



**ROHDE & SCHWARZ**

Manual

**RMS VOLTMETER  
URE**

342.1214.02

Printed in West Germany

## Table of Contents

<u>1.</u>	<u>Data sheet</u>	
	Characteristics	
	Specifications	
<u>2.</u>	<u>Preparation for Use and Operating Instructions</u>	<u>2.1</u>
2.1	Key to Front- and Rear-panel Views	2.1
2.2	Preparation for Use	2.4
2.2.1	Setting Up the Voltmeter	2.4
2.2.2	Rack-mounting the Voltmeter	2.4
2.2.3	Power Supply	2.4
2.2.4	Switching On	2.5
2.3	Operating Instructions	2.6
2.3.1	Connecting the Voltage to be Measured	2.6
2.3.2	Permissible Input Voltages	2.7
2.3.3	Setting the Voltmeter	2.7
2.3.3.1	Measurement Modes	2.7
2.3.3.1.1	AC Measurements	2.8
2.3.3.1.2	DC Measurements	2.8
2.3.3.1.3	AC+DC Measurement	2.9
2.3.3.2	Display of Measured Value	2.9
2.3.3.2.1	Indicating Modes V, dBV and dBm	2.10
2.3.3.2.2	Relative Indication ( $\Delta V$ , $\Delta\%$ , $\Delta dB$ , V/REF)	2.10
2.3.3.2.3	Tendency Indication	2.11
2.3.3.3	Indication of Reference Voltage and Reference Impedance	2.11
2.3.3.4	Measurement Speed	2.12
2.3.3.5	Switchable Low-pass Filter	2.13
2.3.3.6	Switching off Autoranging	2.14
2.3.3.7	Second Functions	2.15
2.3.3.7.1	Entry of Reference Voltage and Reference Impedance	2.15
2.3.3.7.2	Service Functions	2.18
2.3.3.8	Basic Setting	2.20
2.3.3.9	Error Messages	2.21
2.3.4	IEC-bus Control of the URE	2.21
2.3.4.1	Setting the Device Address/Talk Only Mode	2.22
2.3.4.2	Interface Functions	2.23

2.3.4.3	Device IEC-bus Instructions .....	2.23
2.3.4.3.1	Setting Instructions .....	2.24
2.3.4.3.2	Data Entry Instructions (Table 2-6) .....	2.26
2.3.4.3.3	Interface Instructions (Table 2-7) .....	2.26
2.3.4.3.4	Device Trigger Instructions (Tables 2-8 and 2-9) .....	2.26
2.3.4.3.5	Service Instructions (Table 2-9) .....	2.27
2.3.4.4	Data Output .....	2.31
2.3.4.5	Group of Addressed and Universal Instructions .....	2.32
2.3.4.5.1	Remote/Local .....	2.32
2.3.4.5.2	Device Clear .....	2.33
2.3.4.5.3	Device Trigger .....	2.33
2.3.4.5.4	Service Request .....	2.33
2.3.4.5.5	Notes for CEM Computer Users .....	2.34
2.3.4.6	Data Output in Talk Only Mode .....	2.37
2.3.4.7	Retrofitting the IEC-bus Option .....	2.37
2.3.5	Analog Output .....	2.38
2.3.5.1	Retrofitting the Analog Output Option .....	2.39

## Table of Contents

<u>3.</u>	<u>Maintenance</u> .....	3.1
3.1	Measuring Equipment Required .....	3.1
3.2	Check of Voltmeter Operation .....	3.1
3.2.1	Check of Display and Key Functions .....	3.1
3.2.1.1	Displays .....	3.1
3.2.1.2	Keys .....	3.1
3.2.2	Check of AC Measurement Characteristics .....	3.3
3.2.2.1	Error Limits in Voltage Measurements at Lower Frequencies .....	3.3
3.2.2.2	Error Limits in Voltage Measurements at Higher Frequencies .....	3.6
3.2.2.3	Switchable Low-pass Filter .....	3.8
3.2.2.4	Speed Selection of AC Measurements .....	3.9
3.2.2.5	Measurement Rectifier .....	3.11
3.2.2.5.1	Linearity of Measured Values .....	3.11
3.2.2.5.2	Error Limits in RMS Measurements .....	3.12
3.2.3	Check of DC Measurement Characteristics .....	3.13
3.2.3.1	Error Limits in DC Voltage Measurements .....	3.13
3.2.3.2	Speed Selection of DC Measurements and AC Suppression ..	3.15
3.2.4	Check of AC+DC Measurement Characteristics .....	3.16
3.2.5	Check of Input Impedance .....	3.16
3.2.6	Check of Relative Functions .....	3.17
3.2.6.1	Storage of Reference Value and Reference Impedance .....	3.17
3.2.6.2	Check of dBm, dBV and $\Delta$ dB ranges .....	3.18
3.2.7	Check of IEC-bus Interface .....	3.19
3.2.8	Check of Analog Output .....	3.20
3.3	Electrical Maintenance .....	3.20
3.3.1	Autocalibration .....	3.21
3.3.2	Check of Lithium Buffer Battery .....	3.22
3.3.3	Check of Reference Voltages .....	3.22
3.4	Mechanical Maintenance .....	3.23
3.5	Storage .....	3.23

## Table of Contents

4.	<u>Functional Description</u> .....	4.1
4.1	Overall Function .....	4.1
4.2	Computer Board .....	4.4
4.2.1	Power Supply .....	4.7
4.2.2	IEC-bus Interface .....	4.7
4.2.3	Signature Analysis .....	4.8
4.2.4	Analog Output .....	4.9
4.3	Display Board .....	4.9
4.4	Analog Board .....	4.10
4.4.1	Switching Functions .....	4.10
4.4.1.1	Input Switchover .....	4.11
4.4.1.2	Input Amplifier .....	4.11
4.4.1.3	Range Divider .....	4.12
4.4.1.4	Buffer Amplifier .....	4.12
4.4.1.5	Low-pass-filter Selection .....	4.12
4.4.1.6	High-pass-filter Selection .....	4.12
4.4.1.7	Push-pull Amplifier .....	4.12
4.4.1.8	Measurement Rectifier with Filter Circuits .....	4.14
4.4.1.9	DC Amplifier .....	4.15
4.4.1.10	Microprocessor-controlled A/D Conversion .....	4.15
4.4.1.11	DC and AC Reference Voltages .....	4.16
4.4.1.12	Transmission and Decoding of the Analog Control Signals .....	4.17
4.4.1.13	Activation of Analog Switching Functions .....	4.18
4.4.2	Function Sequence .....	4.18
4.4.2.1	Autocalibration .....	4.19
4.4.2.2	RMS-value Measurement and Rectifier Calibration .....	4.20
4.4.2.3	DC Voltage Measurements and Offset Correction .....	4.21
4.4.2.4	Mixed (AC+DC) Voltage Measurements .....	4.22
4.4.2.5	Automatic Range Selection and RANGE HOLD .....	4.23

## Table of Contents

5.	<u>Repair</u> .....	5.1
5.1	Equipment Required .....	5.1
5.2	Troubleshooting .....	5.1
5.2.1	Servicing Aids .....	5.1
5.2.1.1	Service Functions 5 to 9 .....	5.1
5.2.1.2	Error Messages and Evaluation .....	5.3
5.2.1.3	Error Symptoms .....	5.5
5.2.2	Troubleshooting and Check of Power Supply .....	5.6
5.2.3	Troubleshooting and Check of Computer Board .....	5.6
5.2.3.1	Check of Supply Voltages .....	5.7
5.2.3.2	Check of Microprocessor and Peripheral Units .....	5.9
5.2.4	Troubleshooting and Check of IEC-bus Interface .....	5.12
5.2.5	Troubleshooting and Check of Analog Output .....	5.12
5.2.6	Troubleshooting and Check of Display Board .....	5.13
5.2.7	Troubleshooting and Check of Analog Board .....	5.14
5.2.7.1	Check of Interface Functions Analog/Computer Sections .....	5.14
5.2.7.2	Check of Input Circuit and Input Amplifier .....	5.15
5.2.7.3	Check of Range Divider and Buffer Amplifier .....	5.16
5.2.7.4	Check of Push-pull Amplifier .....	5.16
5.2.7.5	Check of RMS-value Rectifier .....	5.17
5.2.7.6	Check of DC-Amplifier Branch .....	5.18
5.2.7.7	Check of Reference Voltages .....	5.20
5.3	Adjustment of the URE .....	5.21
5.3.1	Adjustment of the Analog Board .....	5.21
5.3.1.1	Adjustment of Reference Voltages .....	5.21
5.3.1.2	Rectifier Adjustment .....	5.23
5.3.1.2.1	Offset Adjustment of Push-pull Amplifier .....	5.23
5.3.1.2.2	Balance Adjustment .....	5.23
5.3.1.2.3	Adjustment of Rectifier Amplifier .....	5.23
5.3.1.3	Adjustment of 1-dB Input Divider .....	5.24
5.3.1.4	Absolute-value Adjustment of AC Indication .....	5.24
5.3.1.5	Adjustment of Frequency Characteristic .....	5.25
5.3.2	Adjustment of Analog Output .....	5.27
5.4	Spare Parts .....	5.27

Supplement to  
Manual 342.2704  
URE 342.1214.02

Change data of DC Output Option URE-B2 to read as follows:

Error limits .....  $\pm 2$  mV

# RMS VOLTMETER URE



RMS - VOLTMETER · 10 Hz - 10 MHz · URE 342.1214.02

10.494 V

AC (10 Hz to 10 MHz): 50  $\mu$ V to 300 V  
 DC: 0 to  $\pm$ 300 V

IEC 625 Bus

ACV	.9499	DCV	.314	CCV	1.0000
ACV	.9499	DCV	.315	CCV	1.0013
ACV	.9499	DCV	.315	CCV	1.0011
ACV	.9499	DCV	.315	CCV	1.0012
ACV	.9499	DCV	.315	CCV	1.0009
ACV	.9499	DCV	.310	CCV	1.0000
ACV	.9499	DCV	.310	CCV	.9995
ACV	.9499	DCV	.312	CCV	.9993
ACV	.9499	DCV	.314	CCV	1.0008
ACV	.9499	DCV	.315	CCV	1.0009
ACV	.9499	DCV	.313	CCV	1.0001
ACV	.9499	DCV	.313	CCV	.9999
ACV	.9499	DCV	.314	CCV	1.0008
ACV	.9499	DCV	.314	CCV	1.0007
ACV	.9499	DCV	.311	CCV	1.0005
ACV	.9499	DCV	.310	CCV	.9995
ACV	.9499	DCV	.314	CCV	1.0001
ACV	.9499	DCV	.314	CCV	1.0004



# CHARACTERISTICS

URE

RMS Voltmeter URE ♦ DC, 10 Hz to 10 MHz  
50  $\mu$ V to 300 V

- True rms-value measurement of AC and AC + DC voltages
- Small basic error (0.5%) and high measurement rate (30 measurements/s)
- Readout of measured values selectable in: V, dBm, dBV,  $\Delta$ V,  $\Delta$ dB,  $\Delta$ %
- Entry of reference value and reference impedance for dBm measurements
- Built-in lowpass filters, switch-selected: 4/20/100 kHz
- IEC-bus compatible with option

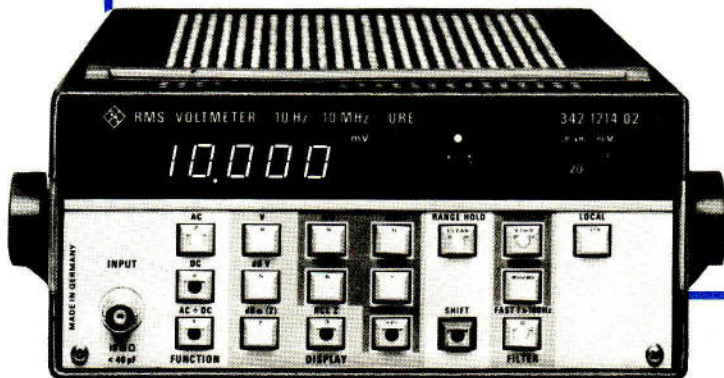

Scale 1:2.5



The **RMS Voltmeter URE** uses an rms-value rectifier circuit of new design and permits true rms-value measurement with wide bandwidth and both high measurement speed and accuracy. A microprocessor provides for error correction and converts the measured values for readout in different selectable units. The IEC-bus interface option permits the use of the URE in automatic test assemblies.

**Measured quantities.** The URE measures DC voltages and the rms value of AC and AC + DC voltages in the frequency range from 10 Hz to 10 MHz (typical range limit at 20 MHz). For AC + DC voltage measurements the microprocessor measures alternately the DC and the AC voltage and determines the total rms value by square-law addition of the individual components.

**Measurement speed.** The URE provides three different measurement speeds: SLOW, FAST and SUPERFAST (1/3/30 measurements per second). The **FAST** button is for switchover between SLOW and FAST. **SUPERFAST** can be selected via the IEC bus or with the aid of service function 3. The lower cutoff frequency of the URE is matched to the selected measurement rate by automatically switched highpass filters in the AC measuring circuit. Hence, low-frequency AC voltages can only be measured at a slow rate, and the DC measuring circuit suppresses AC voltages the better, the lower the measurement rate selected.

**Measuring functions.** The **AC**, **DC** and **AC + DC** buttons permit selection of AC, DC or AC + DC measurement. The measured values are read out in V or mV and autoranging is enabled.

**DC measurement.** In this switch position the URE measures the DC voltage component up to a maximum of  $\pm 300$  V with a resolution of 1  $\mu$ V in the most sensitive measurement range. A higher-order lowpass filter automatically selected with the measurement speed suppresses superimposed AC voltages.

**AC measurement.** In this mode the RMS Voltmeter measures the rms value of AC voltages in the range from 50  $\mu$ V to 300 V at crest factors of up to 5. The frequency range is 10 Hz to 10 MHz (typ. 20 MHz), the lower cutoff frequency as a function of the measurement rate is 10 Hz, 100 Hz or 1 kHz. For suppression of unwanted frequencies the upper cutoff frequency can be limited to 100 kHz, 20 kHz or 4 kHz with the aid of a built-in lowpass filter. The filter is switched in with the **LOWPASS** button, the cutoff frequency of the filter is selected with the **SELECT** button.

**AC + DC measurement.** For AC + DC measurements the URE carries out alternately an AC and a DC measurement and reads out the total rms value of the AC + DC voltage. Voltage components whose frequencies are less than the lower cutoff frequency of the AC measuring circuit are not fully considered. Measurement range and bandwidth are as described under DC and AC measurement.

# FRONT PANEL DETAILS

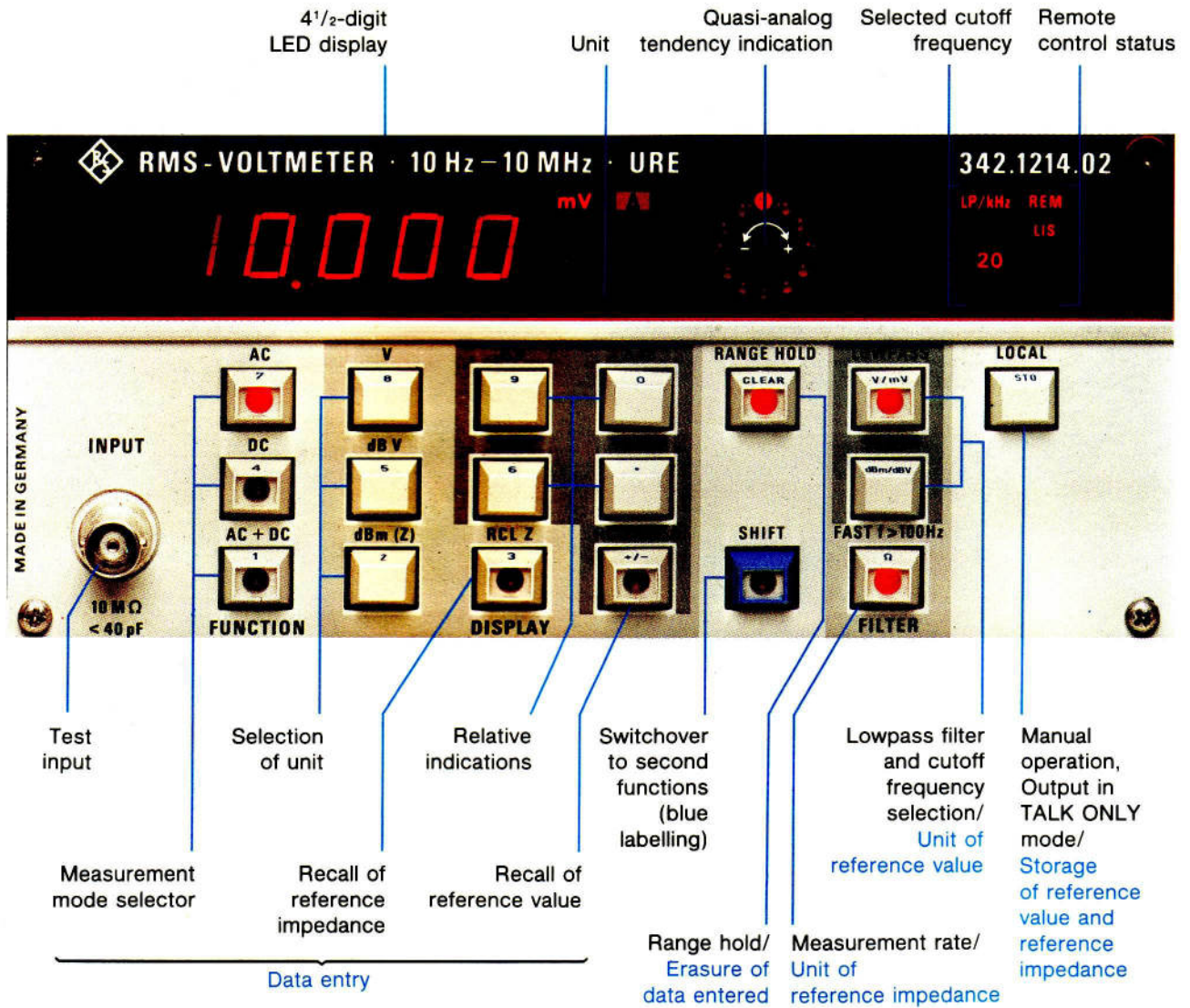

Blue: second functions

**Display of measured value.** The display panel of the URE is subdivided into several sections (see photo on the left). The measured value is read out on a **4<sup>1</sup>/<sub>2</sub>-digit 7-segment LED display** and the associated unit by luminous letters arranged next to it. If the numerical value is positive the sign is blanked. Blinking of the display shows that the result is invalid, e.g. because the range is exceeded. If the measured value is below the range, only the last digit blinks.

For quick detection of any changes in the measured value the URE has a **tendency indication** which also facilitates adjustments and maximum/minimum settings. It consists of LEDs arranged in a circle, the lighted LED corresponding to the momentary measured value. If the measured value becomes higher or lower this light dot follows quasi-analogously clockwise or counterclockwise. The two **illuminated displays** on the right indicate the selected **cutoff frequency of the lowpass filter** for AC measurements and the current **remote control status** of the URE.

**Conversion of measured value.** The microprocessor of the URE converts the measured values, if desired, at the push of a button for readout in different units.

The following readouts can be selected:

	Unit	Button
● Voltage	V or mV	V
● Level	dBV	dBV
● Power level (referred to reference impedance entered)	dBm	dBm(Z)
● Voltage deviation from reference value	V or mV	ΔV
● Relative voltage deviation from reference value in dB	dB	ΔdB
● Relative voltage deviation from reference value in %	%	Δ%
● Ratio of measured value to reference value	-	V/REF

Also indicated are:

- Stored reference value
- Stored reference impedance for power level measurement

Unit	Button
V, mV, dBV, dBm	RCL REF Δ
Ω	RCL Z

Reference values may be entered from 1 μV to 19999 V, reference impedances from 0.1 mΩ to 19999 Ω. The measured value can also directly be used as reference value. The table below shows in detail the many ways of displaying the results in the RMS Voltmeter URE.

**Service functions.** The service functions of the URE are only rarely required and therefore no separate buttons are provided for them. These functions can be called up by pressing a certain combination of buttons. The functions display test, display of IEC-bus address or autocalibration, for instance, can easily be executed by entering a code number via the keyboard.

**IEC-bus Option URE-B1.** This option permits all functions of the voltmeter to be remotely controlled. The maximum measurement speed of 30 measurements per second makes the URE an ideal AF system voltmeter.

**DC Output Option URE-B2.** This output supplies a DC voltage proportional to the indicated numerical value which permits logging of the measured values on a recorder. Thanks to the manifold conversion capabilities of the URE the scale can be linear or logarithmic. The output voltage range is -2 V to +2 V with least increments of 1 mV.

The relationship between the analog output voltage and the measured value is as follows:

Output voltage	Readout without decimal point	Example: Readout	V <sub>out</sub>
V	10 000	11.500 V	+1.150 V
		-37.25 dBV	-0.372 V
		1.13%	+0.011 V

### Example for flexible display of results

Measured values/conversion			Reference values <sup>1)</sup>		Deviations from reference value			
Voltage Button: V/mV	Level		Impedance STO	V, dBV, dBm V/mV, dBV/ dBm; STO	absolute ΔV	ΔdB	relative	
	dBV	dBm (Z)					Δ%	V/REF
10.000 V	20.00 dBV	33.01 dBm	50.00 Ω	1.0000 V	9.000 V	20.00 dB	900.0 %	10.000
1.0000 V	.00 dBV	13.01 dBm		0. V	0. dB	0. %	1.0000	
0.125 mV	-78.06 dBV	-65.05 dBm		-0.999 V	-78.06 dB	-99.98 %	.0001	
1.0000 V	.00 dBV	12.22 dBm	60.00 Ω	.1000 mV	.9999 V	80.00 dB	19999 %	10000
1.0000 V	.00 dBV	11.25 dBm	75.00 Ω		.9999 V	80.00 dB	19999 %	10000
1.0000 V	.00 dBV	6.20 dBm	240.0 Ω		.9999 V	80.00 dB	19999 %	10000
10.000 V	20.00 dBV	22.22 dBm	600.0 Ω	.0010 mV	10.000 V	140.00 dB <sup>2)</sup>	19999 %	19999
2.400 V	7.60 dBV	9.81 dBm		.7750 V	1.625 V	9.81 dB	209.7 %	3.097
10.000 V	20.00 dBV	10.00 dBm	10000 Ω	1.0000 V	9.000 V	20.00 dB	900.0 %	10.00
12.57 V	21.99 dBV	35.00 dBm	50.00 Ω	20.00 dBV	2.570 V	1.99 dB	25.70 %	1.2570
2.236 V	6.99 dBV	20.00 dBm		0. V	0. dB	0. %	1.0000	
25.00 V	27.96 dBV	40.96 dBm		10.00 dBm	24.29 V	30.96 dB	3436 %	35.36

<sup>1)</sup> Entered value or measured value used; values remain stored until new value is entered.

<sup>2)</sup> dBμV.

## Specifications

### Basic unit

<b>Measured parameters</b> .....	DC voltage
	AC voltage
	AC + DC voltage
<b>Frequency range</b>	
Measurement without lowpass filter .....	10 Hz to 10 MHz (typ. up to 20 MHz)
Cutoff frequency (-3 dB) of switch-selected lowpass filters .....	4/20/100 kHz, 40 dB/decade
<b>Measurement ranges</b>	
DC voltage .....	0 to ±300 V
AC voltage .....	50 µV to 300 V
Range setting .....	automatic or manual
automatic .....	when applying the test voltage, with optimum switching speed
manual .....	with RANGE HOLD button: prevents autoranging from switching to a lower range or selection of any range via service function
<b>Input connector</b> .....	BNC female, floating
Input impedance .....	10 MΩ shunted by <40 pF
Loading capacity up to 20 kHz .....	$V_p = 600\text{ V}, V_{rms} = 300\text{ V}$
up to 500 kHz .....	$V_p = 350\text{ V}, V_{rms} = 200\text{ V}$
above 500 kHz .....	$V_{rms} \times f = <10^8\text{ V} \times \text{Hz}$
Max. common-mode voltage .....	<42 V (shock hazard)
<b>Common-mode rejection</b> .....	>120 dB up to 100 Hz
	>100 dB up to 10 kHz
<b>Measurement rate</b> (measurements/second)	
	AC    DC    AC+DC
SLOW ( $f_1 = 10\text{ Hz}$ ) .....	0.8    0.8    0.4
FAST ( $f_1 = 100\text{ Hz}$ ) .....	3      3      1.5
SUPERFAST ( $f_1 = 1\text{ kHz}$ ) .....	30     30     15
Settling times to 0.1% of fsd (without changing the range)	
SLOW .....	1.3 s
FAST .....	270 ms
SUPERFAST .....	25 ms
<b>Weighting</b> .....	true rms-value rectification
Max. crest factor .....	5
<b>Reference value</b> .....	entered via keyboard or directly as measured value
Entry of reference impedance (for dBm measurement) .....	via keyboard, range 0.0001 to 19999 Ω

MADE IN GERMANY

### Readout of measured values

Units of measured parameters (see also text) .....	V or mV
	dBV
	dBm
	ΔV or ΔmV
	ΔdB, Δ%
	ratio (without unit)
Measured value, digital .....	4½-digit 7-segment LED display
Tendency indication .....	quasi-analog indication by light dot travelling in a circle
<b>Resolution in lowest sub-range</b> .....	1 µV
Digital steps .....	10,000
<b>Error limits (at <math>t_{amb} + 15</math> to <math>+30^\circ\text{C}</math>)</b>	
DC .....	0.1% of rdg + 10 digits
AC (crest factor <3) .....	see table below
AC + DC (crest factor <3) .....	see table below, plus 10 digits
<b>Additional error at crest factor 3 to 5</b> .....	3% of rdg
<b>Temperature effect (at <math>t_{amb} + 5</math> to <math>+15</math> and <math>+30</math> to <math>+45^\circ\text{C}</math>)</b>	
DC .....	(0.01% of rdg + 1 digit)/°C
AC, up to 1 MHz .....	0.05% of rdg/°C
up to 10 MHz .....	0.15% of rdg/°C

### Data of options

#### IEC-bus Option URE-B1

Interface to IEC 625-1 standard for control of all operating modes	
Interface functions .....	SH1, AH1, T5, L4, SR1, RL1, DC1, DT1
Connector .....	24-way, Amphenol

#### DC Output Option URE-B2

Output impedance .....	100 Ω
Output voltage range .....	-2 to +2 V
Resolution .....	1 mV/10 digits displayed
Error limits .....	< ±1 mV

### General data

Operating temperature range .....	+5 to +45°C, safety class 1 to IEC 359 (no dew accumulation)
Storage temperature range .....	-40 to +70°C
Power supply .....	100/120/220/240 V ±10%, 47 to 63 Hz (35 VA)
Dimensions, weight .....	220 mm × 109 mm × 340 mm, 4.4 kg

### Ordering information

<b>Order designation</b> .....	► RMS Voltmeter URE 342.1214.02
<b>Options</b>	
IEC-bus Option URE-B1 .....	342.2910.02
DC Output Option URE-B2 .....	342.2810.02
<b>Recommended extras</b>	
19" Rack Adapter ZZA-22 .....	078.8222.00

### Input-voltage-dependent frequency response error

\* This additional error is almost negligible when the lowpass filter is switched into circuit or when considering the calculated inherent noise of the URE.

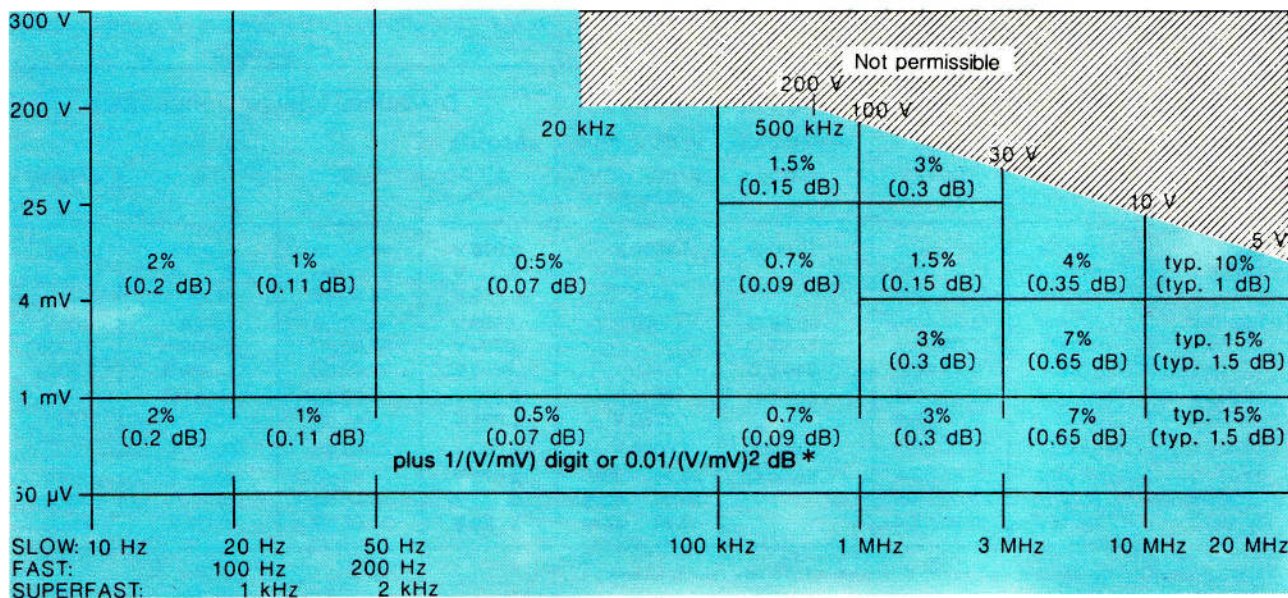

# RMS VOLTMETER URE

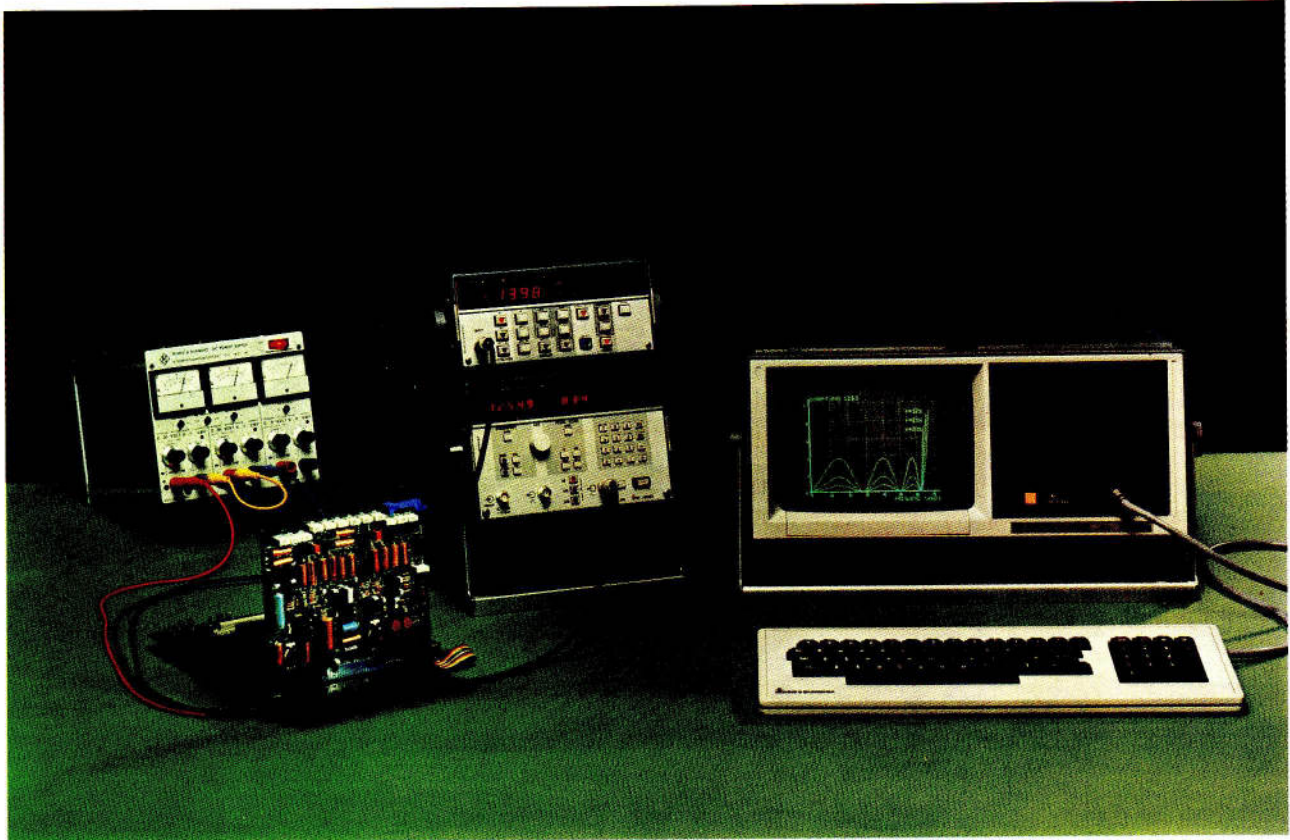

Automatic filter measurement with RMS Voltmeter URE (centre top), Generator SPN (centre bottom) and Process Controller PUC (on the right); on the left: Triple DC Power Supply NGT 20



**ROHDE & SCHWARZ**

GmbH & Co. KG · D-8000 München 80 · Mühlendorfstr. 15 · Tel. (089) 41 29-1 · Int. +49 89 41 29-1 · Telex 523 703  
Printed in the Fed. Rep. of Germany · Subject to change · Data without tolerances: order of magnitude only

382 (F)

## 2. Preparation for Use and Operating Instructions



(See Figs. 2-9 and 2-10 in the appendix)

The values specified in this section are not guaranteed values. The specifications given in the Data Sheet or Technical Information are binding.

### 2.1 Key to Front and Rear-panel Views

Ref. No.	Labelling	Function
1		4 1/2-digit LED display
2	mV $\Delta$ V $\%$ dBm     dB dBV $\Omega$	Illuminated display of the unit. $\Delta$ lights up during relative measurements
3		Tendency indication for quick detection of changes in the measured value.
4	LP/kHz 4 20 100	Illuminated display of low-pass filter cut-off frequency
5	REM LIS TAL SRQ	Illuminated display of Remote status. LIS: Listener address TAL: Talker address SRQ: Service Request
6	LOCAL STO	Key to interrupt Remote status and for data output in Talk Only mode. Second function: To store reference voltage or reference impedance.
7	LOWPASS V/mV  SELECT dBm/dBV	Illuminated key for cutting low-pass filter into AC measuring circuit. Second function: To enter unit, V or mV, of reference voltage. Key for selection of cut-off frequency. Second function: To enter unit, dBm or dBV, of reference voltage.
8	FAST f > 100 Hz $\Omega$	Illuminated key for selecting measurement speed. AC and AC + DC measurement at FAST measurement speed possible only if f > 100 Hz. Second function: To enter unit, ohms ( $\Omega$ ), of reference impedance.

Ref. No.	Labelling	Function
9	RANGE HOLD CLEAR	Illuminated key to maintain measurement range selected by autoranging.  Second function: Clear key for data entry.
10	SHIFT	Illuminated key to select second key functions.
11	RCL REFΔ +/-	Illuminated key to call up stored reference value.  Second function: To select sign for data entry.
12	ΔV 9 ΔdB 0 Δ% 6 V/REF .	Keys for relative indications.  Indication of difference between measured and reference voltage.  Indication of difference between measured and reference voltage in dB.  Indication of difference between measured and reference voltage in %.  Indication of ratio of measured to reference voltage.  Second functions: Digits 9, 0, 6 and decimal point for data entry.
13	RCL Z 3	Illuminated key to call up reference impedance.  Second function: Digit 3 for data entry.
14	V 8 dBV 5 dBm(Z) 2	Keys to select unit of measured voltage.  Indication in V or mV.  Indication in dBV.  Indication in dBm. Z: reference impedance.  Second functions: Digits 8, 5, 2 for data entry.
15	AC 7 DC 4 AC + DC 1	Illuminated keys to select measuring mode.  AC measurement  DC measurement  AC + DC measurement  Second functions: Digits 7, 4, 1 for data entry.

Ref. No.	Labelling	Function
16	INPUT 10 MΩ < 40 pF	Input socket
17		Light bar to indicate SUPERFAST measurement speed.
18	ON POWER OFF	Power switch
19	 $\pm 2$ V <sup>DC</sup> 	Analog output
20	ADDRESS 0 TALK ONLY I NORMAL A5...A1	Address switch for IEC-bus interface. Talk Only mode selector.
21		IEC bus connector
22	 47 - 63 Hz	AC supply receptacle
23	100 V/120 V TO.5B 200 V/240 V TO.25B	Fuse holder/voltage selector



## 2.2 Preparation for Use

### 2.2.1 Setting up the Voltmeter

The URE may be operated in any position. For ease of operation and to facilitate reading the displays, it is best to tilt the voltmeter slightly. For this purpose, press the two ends of the carrying handle together near the pivot, adjust the handle to the desired position and release the handle to let it lock in place.

The URE is designed for operation at an ambient temperature from  $+5^{\circ}\text{C}$  to  $+45^{\circ}\text{C}$ . The ventilation holes in the top and underside of the URE must not be obstructed. Water must not be allowed to condense on the URE. If this has occurred, the URE must be allowed to dry before it is switched on.

### 2.2.2 Rack-mounting the Voltmeter

The URE can be mounted in 19" racks with use of Adapter ZZA-22 (see "Recommended Extras" ). For such mounting, the two covers are replaced by special covers, the carrying handle and the two side strips are removed and a dummy section is screwed to the left-hand or right-hand side of the URE to produce a mountable unit.

### 2.2.3 Power Supply

The URE is designed for operation with AC supply voltages of 100 V, 120 V, 220 V or 240 V  $\pm 10\%$  and frequencies between 47 and 63 Hz. The voltmeter is factory-adjusted for operation by 220 V but is readily adapted for one of the other supplies by lifting off the cover of the fuse holder 22 with a screwdriver, exchanging the fuse if necessary and replacing the cover so that the triangular marker points to the desired voltage (Fig. 2-14 in the appendix). For 220 V and 240 V, insert fuse T0,25B DIN 41571 and for 100 V and 120 V, fuse T0,5B DIN 41571.

Connect the URE to the power outlet via the AC supply receptacle with the power cord supplied. The URE complies with the provisions of VDE 0411 Safety Class I. For safety

connect the URE only to an outlet with a non-fused ground contact.

#### 2.2.4 Switching On

Switch on the URE by means of the power switch on the rear panel of the instrument. The display will read



and subsequently the device address for the IEC-bus connector, for example

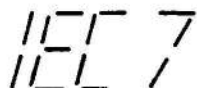

for address 7,

or, in the Talk Only mode



(see section 2.3.4.1).

If the IEC-bus option (Recommended extras) is not incorporated, the display reads

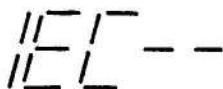

The instrument then assumes its basic setting (see section 2.3.3.8).

## 2.3 Operating Instructions

### 2.3.1 Connecting the Voltage to be Measured

Connect the voltage to be measured via the BNC input socket. If required, an adapter with 4-mm sockets may be used.

The URE has a high-impedance input ( $10\text{ M}\Omega$  shunted by  $< 40\text{ pF}$ ). The external contact of the input socket is isolated from the earthed conductor (Fig. 2-1). The input capacitance is nearly frequency-independent. The input resistance decreases rapidly with increasing frequency as shown in Fig. 2-2. When measuring voltages of higher frequencies via a longer connecting cable, terminate the cable at the URE input so as to prevent measuring errors due to reflections.

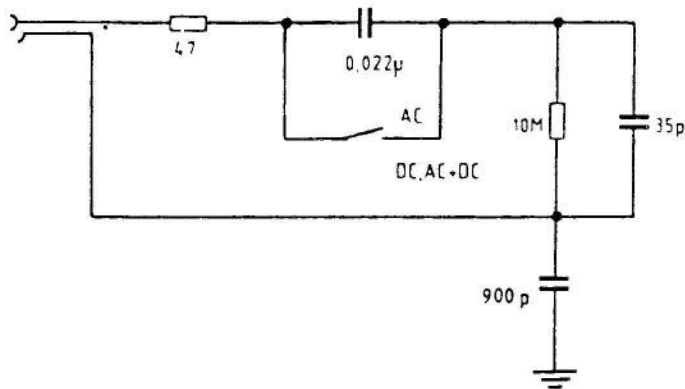

Fig. 2-1 Equivalent diagram of the test input

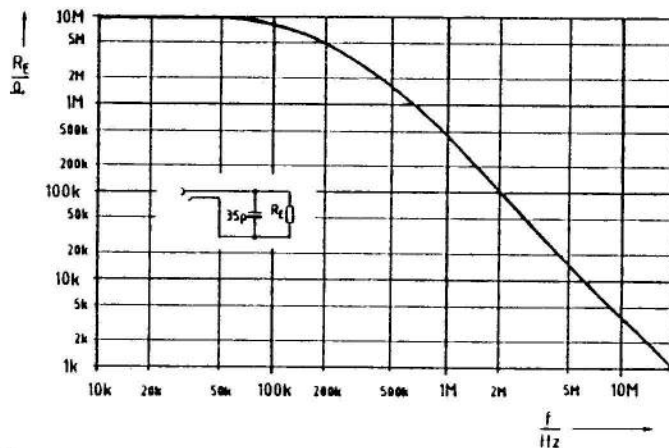

Fig. 2-2 Input resistance

### 2.3.2 Permissible Input Voltages

The URE contains an overvoltage protection circuit. The following conditions must, however, at all times be fulfilled:

- The voltage at the external contact of the input socket must not exceed 42 V relative to the earthed conductor, because of the shock hazard.
- The total peak input voltage (peak AC voltage + DC component) must not exceed 600 V at frequencies up to 20 kHz and 350 V at higher frequencies (Fig. 2-3).
- The rms value of the AC voltage must not exceed 300 V at frequencies up to 20 kHz and 200 V at higher frequencies up to 500 kHz. At frequencies above 500 kHz, it must be reduced so that the voltage-frequency product does not exceed  $10^8$  V · Hz (Fig. 2-3).

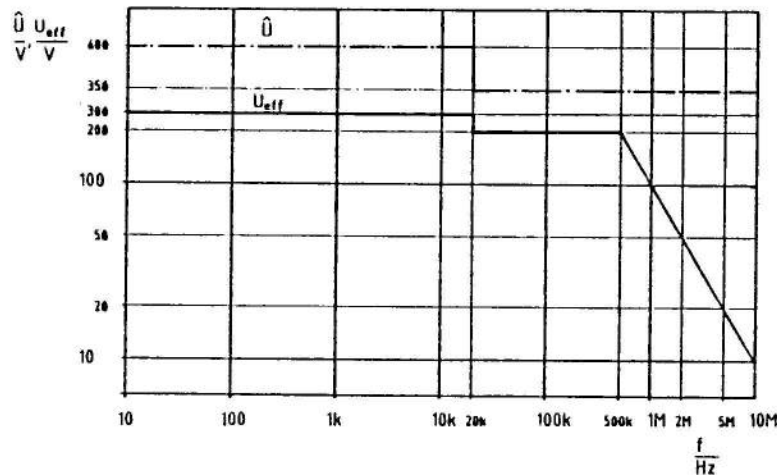

Fig. 2-3 Permissible input voltages

### 2.3.3 Setting the Voltmeter

#### 2.3.3.1 Measurement Modes

The AC, DC or AC+DC measurement mode is selected by pressing the appropriate key. The key lights to indicate the mode selected. Whenever one of the measurement mode keys is pressed, autoranging is switched on (the light of the RANGE HOLD key goes out) and V or mV is selected as display unit. The measurement speed selected is not affected and the state of the low-pass filter in the AC measuring section remains unchanged. In the DC measurement mode, all low-pass filter displays are switched off.

### 2.3.3.1.1 AC Measurements

The URE measures the rms value of AC voltages from 50  $\mu$ V to 300 V with crest factors up to 5. (The crest factor of AC voltages is defined as the ratio of the peak value to the rms value. With sinusoidal voltages it is  $\sqrt{2}$ .)

The bandwidth is greater than 20 MHz but can be reduced to 100 kHz, 20 kHz or 4 kHz by means of the built-in low-pass filter (see section 2.3.3.5).

The lower cut-off frequency is automatically set to 10 Hz, 100 Hz, or 1 kHz, respectively with the selection of the slow, fast or superfast measuring speed (see section 2.3.3.4).

To prevent interference voltages from entering into the test result, it is recommended - in particular with small test voltages - that the input signal be applied via a shielded cable and, if necessary, the low-pass filter be cut in. Make sure that the AC measuring circuit is not overdriven by excessive interference voltage when the low-pass filter is cut in.

In this case switch off the autoranging mode and select the appropriate range.

(see section 2.3.3.6)

The crest factor of AC voltages is in general limited to a maximum of 5. This limit is determined by the voltage range and the accuracy of the rectifier. It is possible to measure AC voltages with higher crest factors so long as the voltage range is not exceeded. The lower the rms value of the input voltage is relative to the selected measurement range, the higher is the permissible crest factor:

$$\text{Permissible crest factor} \leq 6 \times \frac{\text{Voltage range}}{\text{Rms value of voltage being measured}}$$

For the manual setting of voltage range see section 2.3.3.6. The voltage ranges are given in Table 2-2.

### 2.3.3.1.2 DC Measurements

The URE measures DC voltages in the range  $\pm 300$  V, with a resolution of 1  $\mu$ V in the most sensitive measurement range. Superimposed AC voltages can be suppressed by means of a low-pass filter of a higher order which is switch-selected with the measurement speed (see section 2.3.3.4).

By simultaneously monitoring the input AC voltage a less sensitive measurement range is selected automatically if the limit values are exceeded.

### 2.3.3.1.3 AC+DC Measurement

The URE measures the rms value of the total input voltage. For this purpose, an AC measurement and a DC measurement are alternately carried out. The rms value of the total input voltage is then obtained by square-law addition of the two components. Voltage components whose frequencies are less than the lower cut-off frequency of the AC measuring circuit are not fully considered (see section 2.3.3.4).

### 2.3.3.2 Display of Measured Value

The manifold calculation capabilities of the URE permit a test result to be displayed in the usual units V, mV, dBV or dBm or relative to a reference value. The associated keys V, dBV and dBm(Z) as well as  $\Delta V$ ,  $\Delta\%$ ,  $\Delta dB$  and V/REF are interactive and the selected indicating mode is illuminated on the front panel.

The numerical value is read out on a 4 1/2-digit 7-segment LED display. A positive sign is blanked. The result is not valid if the display blinks. Blinking may be caused by the measurement or indicating range being exceeded, as in the indicating mode  $\Delta\%$  or V/REF. If only the last digit blinks, the measured voltage is below the range of accurate measurement for the instrument voltage range cut in. A lower voltage range must then be switched in manually (see section 2.3.3.6).

### 2.3.3.2.1 Indicating Modes V, dBV and dBm

When selecting the indicating mode V, the result - depending on the magnitude of the measured value - is read out in V or mV. The unit V or mV is also selected automatically when one of the measurement mode keys AC, DC or AC+DC has been pressed. A displayed dBV and dBm value ("Vm") is calculated as follows:

$$\begin{aligned} \text{"Vm" dBV} &= 20 \log \frac{|V_m|}{V} & V_m &= \text{measured voltage} \\ & & V &= \text{reference voltage} \\ \text{"Vm" dBm} &= 10 \log \frac{V_m^2 / Z}{1 \text{ mW}} & Z &= \text{reference impedance} \end{aligned}$$

The resolution of the displayed dBV or dBm value is 0.01 dB. The maximum value indicated is +199.99 dBV/dBm.

A reference impedance Z of 0.0001 to 19999  $\Omega$  can be keyed in. The entered value is displayed when the RCL Z key is pressed. See sections 2.3.3.3 and 2.3.3.7.1.

### 2.3.3.2.2 Relative Indication ( $\Delta V$ , $\Delta\%$ , $\Delta dB$ , V/REF)

In relative measurements, the result displayed is the measured value relative to a reference value. There are four possible indicating modes: difference between measured volts and reference volts ( $\Delta V$  key), deviation from reference volts in % ( $\Delta\%$  key), logarithmic deviation ( $\Delta dB$  key), and ratio of measured to reference volts (V/REF key). The reference voltage can be keyed in V, mV, dBV, or dBm. A display of the entered value is obtained by pressing the RCL REF $\Delta$  key. See section 2.3.3.3 and 2.3.3.7.1. It is also possible to use a measured value as a reference value.

The reference voltage is only required internally for calculating the indicated value. It can not be displayed unless it was entered as volts or mV.

The various values displayed are given by the following equations:

$$\begin{aligned} \text{Display } \Delta V &= V - V_{REF} \\ \text{Display } \Delta dB &= 20 \log \frac{V}{V_{REF}} & V &= \text{measured volts} \\ \text{Display } \Delta\% &= \frac{V - V_{REF}}{V_{REF}} \times 100 & V_{REF} &= \text{reference volts} \\ \text{Display } V/REF &= \frac{V}{V_{REF}} \end{aligned}$$

Example:  $V = 10 \text{ V}$ ; reference voltage = 20 dBm; reference impedance = 50  $\Omega$ .

The URE calculates the reference voltage by use of the formula

$$20 \text{ dBm} = 10 \log \frac{V_{\text{REF}}^2 / 50}{1 \text{ mV}} \text{ to give } V_{\text{REF}} = 2.236 \text{ V.}$$

The above equations give the following indicated values:

Display  $\Delta V = 7.764 \text{ V}$ ; Display  $\Delta\% = 347.2\%$ ; Display  $\Delta\text{dB} = 13.01 \text{ dB}$ ;

Display  $V/\text{REF} = 4.472$ .

The resolution of measured values in the indicating modes  $\Delta\%$  and  $\Delta\text{dB}$  is 0.01% and 0.01 dB respectively, with maximum indicated values  $+19999\%$  and  $+199.99 \text{ dB}$ . If the indicated value is  $> 199.99\%$ , the resolution is lessened. The indicating range for the ratio of measured to reference voltage is 0.001 to 19999.

To identify relative readouts, the symbol  $\Delta$  lights up in addition to V, mV, % or dB as called for; when the ratio of measured to reference voltage is read out, only the symbol  $\Delta$  lights up.

#### 2.3.3.2.3 Tendency Indication

For quick detection of changes in the indicated value, a number of LEDs are arranged in a circle to provide a "tendency indication". The lighted LED corresponds to a particular indicated value. If the indication changes to a higher value, the light spot travels clockwise and if the indication drops to a lower value, the light spot travels counterclockwise. The tendency indication is also operative when the reference voltage or impedance is read out and when the keys are switched over to the second function. Thus the input voltage can be constantly monitored.

With AC and DC measurements the tendency indication is switched off.

#### 2.3.3.3 Indication of Reference Voltage and Reference Impedance

When the RCL REF $\Delta$  is pressed, the stored reference voltage for relative measurements is displayed. When the RCL Z key is pressed, the reference impedance for dBm measurements is displayed. The selected key lights while all other keys go out. The reference voltage is displayed in the unit in which it was entered, i.e. in V, mV, dBV or dBm. During display of the reference voltage or reference impedance, the measuring section of the URE remains unchanged and autoranging and tendency indication remain active.



To reset the URE to the originally displayed measured value, the key involved, RCL REFA or RCL Z, is simply pressed again. It is also possible to obtain a new setting by pressing the function key AC, DC, or AC+DC, and key V, dBV, dBm(Z),  $\Delta V$ ,  $\Delta\%$ ,  $\Delta dB$  or V/REF.

#### 2.3.3.4 Measurement Speed

The URE provides three measurement speeds:

SLOW (0.8/s), FAST (5/s) and SUPERFAST (50/s). Switchover from SLOW to FAST and vice versa is accomplished by means of the FAST key which lights when the FAST rate is selected. SUPERFAST can be selected with the aid of service function 3 (see section 2.3.3.7.2). The SUPERFAST setting is indicated by a light bar in front of the display. Because at SUPERFAST the measurement rate is slightly influenced by the selected output unit, output in volts must be set for maximum measurement speed.

is in volts. It can be selected with the aid of service function 3 (see section 2.3.3.7.2). The SUPERFAST setting is indicated by a light bar in front of the display.

The measurement rate is ganged with the filtering of the DC voltage which is applied to the A/D converter of the URE. The lower the selected measurement rate is, the lower are the cut-off frequencies of the two smoothing filters at the outputs of the AC and the DC measuring circuits. Hence, low-frequency voltages can only be measured at a slow rate, and the DC measuring circuit suppresses AC voltages the more efficiently the lower the measurement rate selected. Fig. 2-4 shows the frequency characteristic of the DC measuring circuit as a function of the measurement rate.

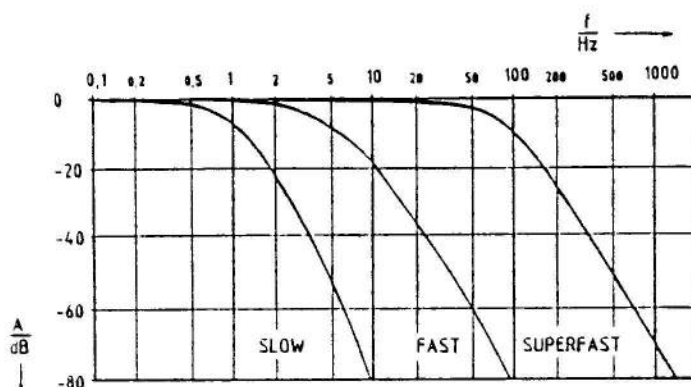

Fig. 2-4 Frequency characteristic of the DC measuring circuit as a function of the measurement rate

In addition to the above-mentioned filtering of the rectified AC voltage, the lower cutoff frequency of the AC measuring circuit is selected together with the measurement rate. The 3-dB cut-off frequency is 10 Hz at the SLOW, 100 Hz at the FAST and 1 kHz at the SUPERFAST measurement speed. Fig. 2-5 shows the frequency characteristic of the AC measuring circuit as a function of the measurement rate. Switchover of the lower cutoff frequency offers the advantage that transients such as occur during range switching may be matched to the measurement rate.

Since the DC and the AC voltage components are measured alternately when carrying out AC+DC measurement, the same applies with respect to the influence of the measurement speed as has been said above.

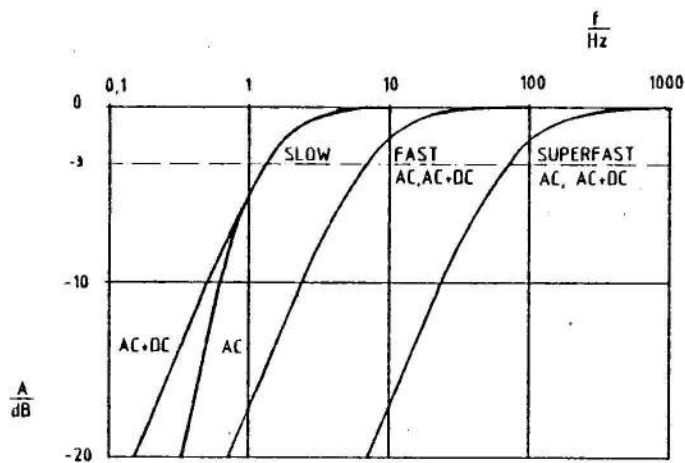

Fig. 2-5 Frequency characteristic of the AC measuring circuit as a function of the measurement rate.

### 2.3.3.5 Switchable Low-pass Filter

For suppression of unwanted frequencies when measuring AC or AC+DC voltages, the rectifier in the AC measuring circuit is preceded by a switchable low-pass filter which can be cut in and out by means of the LOWPASS key. With the filter cut in, three cut-off frequencies 4, 20 and 100 kHz are selectable (3-dB points) in the order 4 kHz, 20 kHz, 100 kHz, 4 kHz ... by pressing the SELECT key. The selected cut-off frequency and LP/kHz are illuminated and the LOWPASS key lighted. The cut-off frequency setting is not changed when the filter is switched in and out or the measuring mode is changed. When measuring DC voltage, the LOWPASS key and the cut-off frequency display are unlighted.

Since the low-pass filter used (2nd-order Butterworth filter) suppresses interference voltages very effectively, an interference voltage in the rejection region of the filter that is large in comparison with the voltage being measured can result in the URE input circuits being overdriven. As a rule of thumb, the components rejected by the filter should not be greater than the components passed. If they are greater, a larger voltage range must be selected manually (see section 2.3.3.6).

Fig. 2-6 shows the frequency response of the switchable low-pass filter.

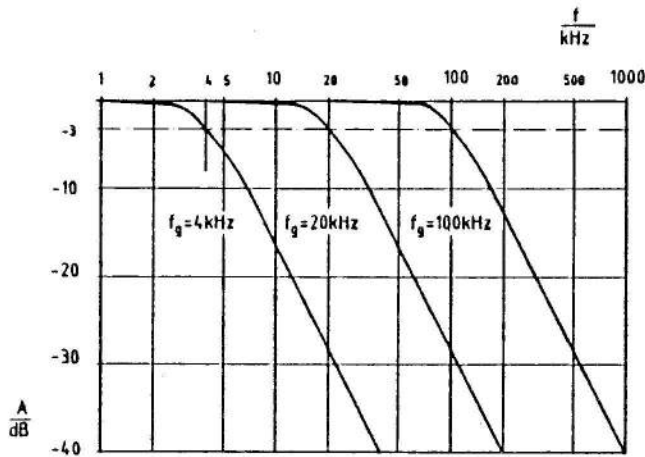

Fig. 2-6 Frequency response of the switchable low-pass filter

### 2.3.3.6 Switching off Autoranging

The URE is a voltmeter with autoranging, the switching speed of autoranging being matched to the measurement speed. There are cases, however, where it is preferable to switch off autoranging and maintain a fixed voltage range. The RANGE HOLD key permits a voltage range selected by autoranging to be maintained. It is also possible to select any desired range with the use of service function 2 (see section 2.3.3.7.2). In both cases, the RANGE HOLD key lights. Automatic ranging can be switched back on by pressing the RANGE HOLD key again or by changing the measurement mode.

Holding an automatically selected voltage range is useful when the input voltage is switched off momentarily and switchover to the most sensitive range is to be avoided. Range selection with the use of service function 2 may be necessary to avoid overdriving of the amplifiers with the low-pass filter switched in. (See section 2.3.3.5 Switchable Low-pass Filter).

The measurement accuracy decreases very fast in the case of an undervoltage in the AC or DC measuring circuit. Therefore, the last digit of the display blinks when the measured AC voltage is less than 30% and the measured DC voltage is less than 10% below the nominal value. When this range is exceeded, i.e. when the measured value is more than 20% above the nominal upper limit of the range, or the AC-voltage proportion exceeds certain levels with DC measurements, the whole display blinks. The URE then changes over to the next higher voltage range. After the excessive voltage has been removed, the instrument returns to the original range. The voltage ranges are listed in Table 2-2.

With AC+DC measurement the AC and the DC circuits are tested separately for overvoltage and undervoltage. The range limits for both circuits are between 30% and 120% of the nominal upper limit of the voltage range.

### 2.3.3.7 Second Functions

The second functions of the keyboard - blue engravings on the keys - are used for entering data, such as the reference voltages for relative indications and the reference impedance for dBm measurements, as well as for calling up service functions, such as autocalibration. Switchover to the second functions is accomplished by means of the SHIFT key. This key lights when the second functions are selected; all other keys go out. The entire measuring circuit remains unchanged and the tendency indication and auto-ranging remain active. If the reference voltage or impedance is displayed at the time the second functions are switched in, the URE then automatically displays the last measured value.

#### 2.3.3.7.1 Entry of Reference Voltage and Reference Impedance

For dBm measurements with the URE, a reference impedance must be entered and for relative measurements a reference voltage. For each of these quantities, a store is provided, whose contents are overwritten by a new entry. The store contents are not erased when the voltmeter is switched back on. The reference impedance is entered in ohms ( $\Omega$ ) and for the reference voltage V, mV, dBV or dBm can be chosen.

To enter a reference voltage or reference impedance, key in the appropriate number and unit, which are then displayed, and store the displayed entry by pressing the STO key. The URE automatically identifies an  $\Omega$  entry as a reference impedance and a V, mV, dBV or dBm entry as a reference voltage.

If the URE accepts the entry when the STO key is pressed, it automatically resumes its last setting. If an entry is illegal, the URE first displays the message

Err

and then resumes the setting it had prior to the pressing of the STO key. Illegal entries are:

- Reference voltage greater than  $\pm 199.99$  dBV/dBm
- Reference impedance negative or equal to zero.

For entry of the desired values, the second functions of the URE keys are used. These keys fall into two independent groups:

- 1) Numerical keys 0 to 9, decimal point key, +/- sign changeover key, CLEAR key
- 2) Unit keys, V/mV, dBV/dBm,  $\Omega$ .

The entry of the numerical value with the keys of group 1 is performed in the same manner as with pocket calculators. The +/- sign can be changed during the entry as desired and a faulty entry can be corrected with the CLEAR key.

When pressing one of the unit keys, the first unit - V or dBV - is selected unless it has already been displayed. If the latter is true, the second unit - mV or dB - is selected. The unit can be changed during the entry as desired and is not influenced by the CLEAR key.

Example: Entry of reference value of 150.1 mV.  
Initially the URE is in normal operation, display in V. After entry of reference value, the URE is switched over to relative measurement -  $\Delta$ dB.

<u>Keys</u>	<u>Display</u>
	3.002 V
SHIFT	
	3.002 V
1	
	1. V
5	
	15. V
0	
	150. V
.	
	150. V
1	
	150.1 V
V/mV	
	150.1 mV
STO	
	3.002 V
$\Delta$ dB	
	26.02 dB

As this example shows, the readout present prior to the switchover to the second function is preserved. It could be used immediately as the new reference value by storing it with the STO key. This is also the case if the URE was previously set for a relative measurement, but in this case, the volt-value corresponding to the readout would be stored with the STO key.

Example: Entry of the last value measured as reference value.

Initially the URE is in normal operation, display in V.

Then it is switched over to relative measurements -  $\Delta\%$  -.

After entry- display of reference value.

<u>Keys</u>	<u>Display</u>
	14.14 V
RCL REFA	
	14.392 V
$\Delta\%$	
	-1.75 %
SHIFT	
	-1.75 %
STO	
	0.00 %
RCL REFA	
	14.14 V

### 2.3.3.7.2 Service Functions

The service functions of the URE are special device functions. They are only rarely required so that no particular key is provided for them. They are called up by pressing the SHIFT key to activate the second functions of the URE keys and then pressing the decimal point key "." three times in succession. The readout on the display is then



and after entry of the required code, as given in Table 2-1, the selected function is executed. After execution of functions 0 to 4, the URE resumes its last setting.

Table 2-1 Service functions

Code	Function		
0	Display test		
1	Display of IEC-bus address		
2	Selection of voltage range		
3	Measurement speed SUPERFAST		
4	Autocalibration	see section	3.3.1
5	Absolute value adjustment	" "	5.2.1.1
6	Rectifier adjustment	" "	5.2.1.1
7	Analog output - offset adjustment	" "	5.2.1.1
8	Analog output - amplifier adjustment	" "	5.2.1.1
9	Reference voltage adjustment	" "	5.2.1.1

Example: Display of IEC-bus address

<u>Keys</u>	<u>Display</u>
	XXXXX
SHIFT	XXXXX
.	0.
.	0.
.	- SEr -
1	IEC 7
	XXXXX

Service function 0 - display check - causes all indicating elements including the illuminated keys to light for about 3 s.

Service function 3 permits the measurement speed SUPERFAST to be selected. After this, the FAST key lights up and in the left corner of the display an illuminated bar appears. By pressing the FAST key, the URE is reset to FAST measurement speed.

The service function 4 is dealt with in section 3.3.1.

The service functions 5 to 9 are dealt with in section 5.2.1.1.

Only service function 2 - selection of voltage range - will be discussed here.

After pressing the code number 2 for this service function, the desired range number, given in Table 2-2, is entered and the instrument goes over into this measurement range. After resetting to measured value display, the RANGE HOLD key lights. Since the DC measurement circuit, owing to its enhanced dynamic characteristics, permits the voltage ranges to be graduated in 20-dB steps, only those ranges that are not marked with an asterisk in Table 2-2 can be selected for measuring DC voltages. If another range is selected, the URE automatically switches over to the next higher DC range. Note that prior to setting the voltage range, the measurement mode - AC, DC or AC+DC - must be selected.

Table 2-2 Range numbers for service function 2

Range number	Measurement range
01	1 mV <sup>+) )</sup>
02	3 mV <sup>+) )</sup>
03	10 mV
04	30 mV <sup>+) )</sup>
05	100 mV
06	300 mV <sup>+) )</sup>
07	1 V
08	3 V <sup>+) )</sup>
09	10 V
10	30 V <sup>+) )</sup>
11	100 V
12	300 V

<sup>+) )</sup> Only possible for measuring AC and AC+DC voltages.



Example: Setting of measurement range 1 V

<u>Keys</u>	<u>Display</u>
	XXXXX
SHIFT	XXXXX
.	0.
.	0.
.	- SEr -
2	2 --
0	2 0 _
7	2 07
	XXXXX

### 2.3.3.8 Basic Setting

The basic setting of the URE is automatically activated when the instrument is switched on. This setting is also switched in via IEC-bus control with the commands CL or DCL (Device Clear) or SDC (Selected Device Clear) (see sections 2.3.4.3.1 and 2.3.4.5.2).

The basic setting is as follows:

Measurement mode	AC
Output of measured voltage in	V
Measurement speed	FAST
Low-pass filter	OFF
RANGE HOLD	OFF

Furthermore, the IEC-bus interface is set to the delimiter CR+NL (Carriage Return and New Line) for data output (W3), and no Service Request is sent (Q0). Alphanumeric data output (N0) via IEC bus, and the URE operates without the measuring time being reduced (V0).

The basic setting corresponds to the following sequence of IEC-bus instructions

RA0, U0, F1, L0, W3, Q0, N0, V0.

The reference voltage and the reference impedance are not affected by the basic setting.

### 2.3.3.9 Error Messages

The display

A digital display showing the error code 'E-1-'. The characters are formed by horizontal and vertical bars, with the first bar being longer than the others.

followed by a hexadecimal 1...F indicates that the URE is not functioning properly. The errors causing this display are described in section 5.2.1.2. By pressing a DISPLAY key, the error message display is erased and data display selected. If the error occurs again, the error message is again displayed.

Regarding the display

A digital display showing the error code 'E-1-0'. The characters are formed by horizontal and vertical bars, with the first bar being longer than the others.

see section 2.3.3.7.1.

When displaying the reference values (key RCL Z or RCL REF Δ) or when changing over to the second functions (key SHIFT) the error message remains erased, and appears again only when switching over to data display.

### 2.3.4 IEC-bus Control of the URE

The URE may be fitted with a remote-control interface in accordance with IEC Publ. 625-1 for connecting it into an IEC-bus system for transfer of setting and measurement data. This permits all functions of the URE to be remote-controlled. The IEC-bus connector 20 (Fig. 2-7) is located on the rear panel of the URE. For retrofitting the IEC-bus option see section 2.3.4.

The interface characteristics of the IEC bus (control lines, handshake lines, data lines) as well as the data transfer sequence are laid down in the relevant standards. The ASCII characters used for data transfer are listed in Table 2-15.

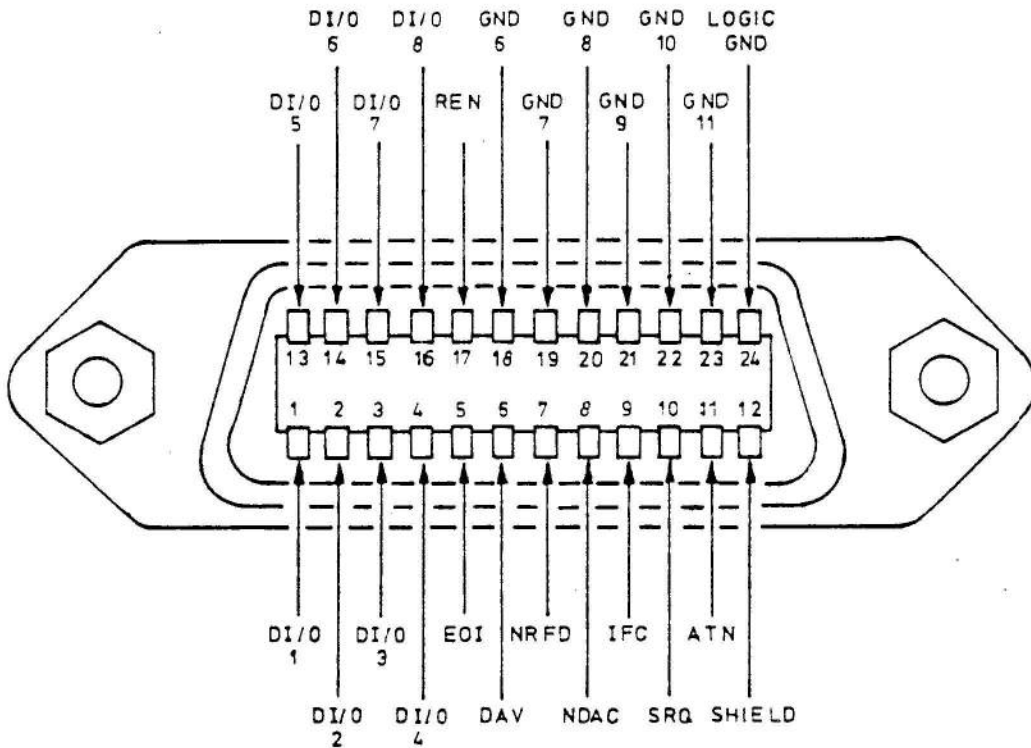

Fig. 2-7

2.3.4.1 Setting the Device Address/Talk Only Mode

The address switch (coding switches A1 to A5) provides for setting the device address in binary code. Table 2-14 shows the relationship between device address, switch positions, and ASCII characters for listener and talker address. the URE is factory-set to device address 7.

The Talk Only mode (see section 2.3.4.6) is also set by means of the address switch with the extreme right coding switch in TALK ONLY position.

The setting of the address switch is read in at switch-on and by calling up service function 1 (display of IEC-bus address) and read out on the display (see section 2.2.4).

### 2.3.4.2 Interface Functions

The URE implements the following interface functions:

SH1	Source handshake function, complete capability
AH1	Acceptor handshake function, complete capability
T5	Talker function, capability to answer serial poll, unaddressing if MLA, Talk Only mode
L4	Listener function, unaddressing if MTA
SR1	Service Request, complete capability
RL1	Remote/local switchover function, complete capability
DC1	Device Clear function, complete capability
DT1	Device Trigger function, complete capability

### 2.3.4.3 Device IEC-bus Instructions

These instructions can be subdivided into five groups:

- 1) Setting instructions (Tables 2-4 and 2-5)  
Serve for setting the measurement and analysis circuit without initiating a measurement.  
Example: Setting of voltage range.
- 2) Data entry instructions (Table 2-6)  
Permit reference voltage and reference impedance to be entered.
- 3) Interface instructions (Table 2-7)  
Serve for setting IEC-bus interface.  
Example: Selection of delimiter for data output.
- 4) Device trigger instructions (Table 2-8)  
Initiate a device function at the accomplishment of which a result is written into the output buffer which can be output after addressing talker.

#### 5) Service instructions (Table 2-9)

Required for necessary adjustments or repair of the device (see sections 3..., 4..., 5...).

The service instructions are of the same type as the setting and device trigger instructions.

All IEC-bus device instructions consist of an alphanumeric header, the numeric content, a separator, which separates several instructions from each other, and delimiters which terminate a sequence of instructions (Table 2-3). The header consists of one or two ASCII upper-case letters and a numeric part of, in general, one or two digits. The numeric content may in addition to numbers include decimal point, sign, and the upper-case letter E, for exponent. Any of the delimiters may be used. Spaces may be used in the instruction sequence.

Example of instruction sequence (Controller PUC):

```
IECOUT7, "instruction 1, instruction 2, instruction 3" /CR/NL/
```

All the instructions received are checked for correct syntax, and all the data received are checked to see that they are within the limit values. If errors are found, these instructions are not executed and instead - after the interface is set as required (Table 2-7) - a Service Request with appropriate status-byte coding (Table 2-13) is generated.

#### 2.3.4.3.1 Setting Instructions (Tables 2-4 and 2-5)

C1 activates the basic setting of the URE (see section 2.3.3.8 Basic Setting) and corresponds to the following sequence of instructions

RAØ, UØ, F1, LØ, W3, QØ, NØ, VØ.

With the instructions FØ to F2 the measurement speed of the URE is set (see section 2.3.3.4 Measurement Speed).

With the instructions L1 to L2 the low-pass filter in the AC circuit is set to the required limit frequency and is cut off again with instruction LØ (see section 2.3.3.5 Switchable Low-pass Filter).

With setting NØ in data output the numerical value is preceded by an alphanumeric header of six characters (see section 2.3.4.4). The header can be suppressed with instruction N1.

Instructions UØ to U6 determine the output unit (see sections 2.3.3.2.1, 2.3.3.2.2 and 2.3.4.4).

The instructions V $\emptyset$  to V2 allow for a compensation of the time delay between the measurement voltage and the trigger instruction making thus optimum use of the short measuring time in the SUPERFAST mode.

Example:

The URE receives together with the voltage to be measured a trigger instruction. After the elapse of measurement time  $T_M$ , the measurement value can be read off from the output buffer.

If with respect to the voltage to be measured, the trigger instruction arrives with a delay of 10 ms on the URE, the measurement value would be available at the output buffer only after  $T_M$  plus 10 ms.

With the instruction V2 the delay of 10 ms could be taken into account so that for the above example the measurement value would also be available after  $T_M$  as referred to the measurement voltage. The accuracy of the result will not be affected as long as the compensation time selected remains below the actual delay time.

The instruction V $\emptyset$ , V1 or V2 remains active until change over.

With instruction V? the selected compensation time can be read out.

With the Interface Q1 set correspondingly, the URE communicates Service Request after receiving instruction V?. By decoding the status byte the compensation time can be read out (see section 2.3.4.5.4. Service Request).

With the instructions RA/range number/, RD/range number/ and RC/range number, the function and voltage range are always set together. In contrast to key control, the output unit is not affected when the function is changed. Since the DC measuring circuit with its greater dynamic range permits division of the measurement ranges in 20-dB steps, only the ranges not marked with an asterisk in Table 2-5 can be set when measuring DC voltage. If an unpermitted range is selected, the URE automatically switches to the next higher measurement range. Thus, for example, the instructions

RD1, RD2 and RD3

all have the same effect - they set the 10-mV range.

#### 2.3.4.3.2 Data Entry Instructions (Table 2-6)

The data can be entered with or without exponent. The exponent may consist of two digits maximum and the (+/-) sign. The length of the mantissa can be freely chosen. However, only so many characters are accepted as could be entered in the display by hand (see section 2.3.3.7.1). A positive sign or a zero before the decimal point can be entered or not. Spaces do not affect the entry.

Example: Entry of a reference value of 0.316 V.

The following instructions are all equivalent:

DVO/.316, DV.316, DV+Ø.316, DV Ø.316, DV316E-3.

#### 2.3.4.3.3 Interface Instructions (Table 2-7)

The delimiter of the data output is set by means of WØ,...,W8. Status-byte coding in the case of a Service Request is described in section 2.3.4.5.4 (Table 2-13).

#### 2.3.4.3.4 Device Trigger Instructions (Tables 2-8 and 2-9)

Like the universal instruction GET (see section 2.3.4.5.3), the trigger instruction X1 causes the URE to start a measurement at the selected settings and store the result in the output buffer. With the interface set appropriately, a Service Request is sent at the end of the measurement.

The instruction X2 has the same effect as X1 or GET with the difference that the measured value is used as reference value.

Two special features of X2 should in addition be high-lighted:

If one of the relative units (control character U3...U6) is selected for the output unit, the measured value obtained by instruction X2 is expressed relative to the original reference value. The reference value produced by X2 is used for the evaluation of measured values only after subsequent triggering. This is due to the following measurement cycle of the URE:

1. Measurement
2. Evaluation with the (original) reference value
3. Transferring measured value to output buffer
4. Storing measured value as (new) reference value

If the control character X2 is used, it should always be sent before the terminator since the URE is inhibited for further commands on the reception of X2. In other words, with setting commands sent after X2 the IEC bus remains

blocked until X2 is processed (i.e. 1.2 s for SLOW speed of measurement).

The instruction X3 is not an inhibiting instruction in the real sense, but it sets the URE so that a command for measurement from the controller initiates triggering.

Example (PPC):

```
IECOUT7, "X3"          (setting up trigger logic)
.
.
.
.
IECIN7, A8             (triggering and read in of measured value
                       for variable A8)
```

The instruction X3 offers the advantage of doing away with the special trigger instruction (X1, X2, GET) which brings about a higher speed of measurement.

Like X3 the instruction X4 is a setting instruction and performs sequence measurements, i.e. the URE starts a measurement by itself and continues with the next provided that the previous measurement is completed. This enables to attain the highest possible speed of measurement.

The settings of X3 and X4 can be reset with the control character X0.

The instructions Z0 and Z1 cause the URE to store the reference voltage or reference impedance in the output buffer.

The instructions SA, ..., SP permit device calibration data and error numbers to be stored in the output buffer (see section 5.2.1.2). By talker address, the output buffer can be read out, but only once. No instruction may be sent between the trigger instructions and talker address. The output data format is described in section 2.3.4.4.

#### 2.3.4.3.5 Service Instructions (Table 2-9)

These instructions serve the same purpose as their corresponding service functions. For more details see sections 3.3.1 and 5.2.1.1.

Since autocalibration of the URE takes several seconds, the service instruction S4 should only be sent alone or at the end of an instruction sequence. This prevents the IEC bus from being blocked while the instruction is being executed.



Table 2-3 Separator and delimiters

Symbol	Name	ASCII decimal equivalent	Application
,	Komma	44	Separator between individual instructions
CR	Carriage Return	13	Delimiters
NL	New Line	10	
ETX		3	

Table 2-4 Setting instructions

Instruction code	Function
C1	Basic setting
F0 F1 F2	SLOW FAST SUPERFAST Measurement speed
L0 L1 L2 L3	OFF 4 kHz 20 kHz 100 kHz Low-pass filter
NØ N1	Output with Output without Alphanumeric header
U0 U1 U2 U3 U4 U5 U6	V dBV dBm $\Delta V$ $\Delta\%$ $\Delta dB$ V/REF Output unit
VØ V1 V2	Ø ms 5 ms 10 ms Compensation time with trigger delay
V?	Request for compensation time (Service request with correspondingly set status byte)
RA/range number/ RD/range number/ RC/range number/	AC DC AC+DC Function + voltage range.

Table 2-5 Setting instructions - range numbers

/Range number/	Measurement range
0	Autoranging
1	1 mV <sup>+</sup> )
2	3 mV <sup>+</sup> )
3	10 mV
4	30 mV <sup>+</sup> )
5	100 mV
6	300 mV <sup>+</sup> )
7	1 V <sup>+</sup> )
8	3 V <sup>+</sup> )
9	10 V
10	30 V <sup>+</sup> )
11	100 V
12	300 V

+ ) Only when measuring AC or AC+DC

Table 2-6 Data entry instructions

Instruction code	Function
DV/data/	Reference voltage in V
DB/data/	Reference voltage in dBV
DM/data/	Reference voltage in dBm
DZ/data/	Reference impedance in ohms ( $\Omega$ )

Table 2-7 Interface instructions

Instruction code	Function
W0 NL	Delimiters
W1 CR	
W2 ETX	
W3 CR+NL	
W4 EOI	
W5 NL+EOI	
W6 CR+EOI	
W7 ETX+EOI	
W8 CR+NL+EOI	
Q0 No SRQ	
Q1 SRQ	
H1	(see section 2.3.4.5.5)

Table 2-8 Device trigger instructions

Instruction code	Function
X0	Reset function for instruction
X1	X3 and X4
X2	Trigger instruction = GET
X3	Trigger instruction plus transferring measurement value as reference value
X4	Setting instruction for triggering with request for measurement
	Setting instruction for sequence of measurement
Z0	Output reference voltage
Z1	Output reference impedance

Table 2-9 Service instructions

Instruction code	Function
S0	Display check
S1	Reference voltage adjustment 100 mV
S2	Reference voltage adjustment 1 V
S3	Reference voltage adjustment 10 V
S4	Autocalibration
S5	Absolute value adjustment
S6	Rectifier adjustment
S7	Analog output - offset adjustment
S8	Analog output - gain adjustment
SA	1
SB	2
SC	3
SD	4
SE	5
SF	6
SG	7
SH	8
SI	9
SJ	10
SK	11
SL	12
SM	13
SN	14
	Display of calibration data of measurement range
S0	Display of linearity coefficient of rectifier
SP	Display of error number

### 2.3.4.4 Data Output

The URE can output the measured data, the reference voltage, the reference impedance, the error number, and the device calibration data. The output format is the same for the Talk Only mode and the talker status after having been addressed by the controller. The output may either be a numerical value (control character N1) or a numerical value with a preceding six character alphanumeric header (control character N0). The numerical value is preceded by a total of six characters (Fig. 2-8), namely two characters for the measuring function (Table 2-10, three characters for the unit (Table 2-11), and one character for identifying the output data when the measurement range is exceeded or the reference value is output, etc., (Table 2-12). The code H is displayed not only for overrange but also when auto-ranging of the URE is stopped after several unsuccessful search of range.

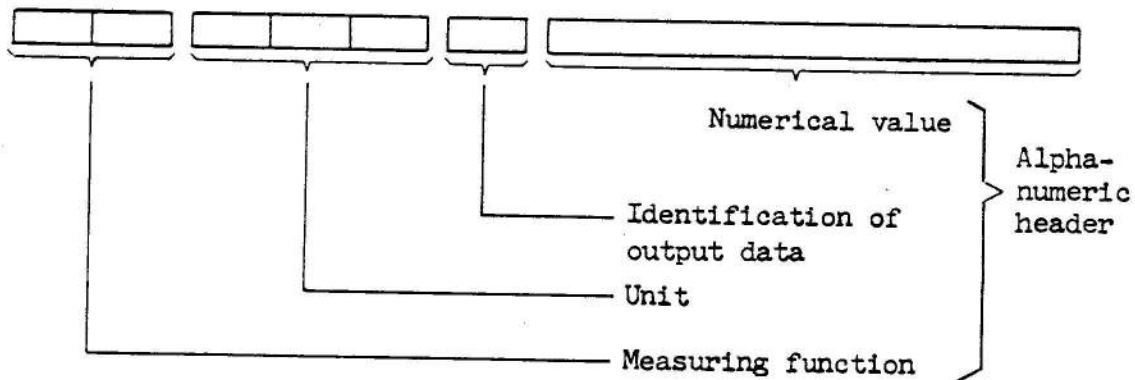

Fig. 2-8 Data output format

The numerical value is generally not output with exponent. The exponent E-3 is added only if mV is displayed.

Example:            Output of valid measured data 177.3 mV (DC)  
                       DCV---177.3 E-3

                      Output of measured data 12.17 dBm (AC) if below range limit  
                       ACDEMU12.17

                      Output of reference value 9.502 V  
                       --V--R9.502

The data output is terminated by the set delimiter (Table 2-7).

Table 2-10 Coding of measuring function for data output

Code	Measuring function
AC	AC
DC	DC
CC	AC+DC
--	Output of reference voltage, reference impedance or calibration value

\_: Space

Table 2-11 Output unit coding

Code	Output unit
V--	V
DEV	dBV
DEM	dBm
DV-	$\Delta V$
D%-	$\Delta\%$
DDB	$\Delta dB$
REL	V/REF
OHM	$\Omega$
---	with calibration value

Table 2-12 Identification of output data

Code	Function
-	Valid measured data
H	Above range limit
O	Overflow of readout
R	Reference voltage/Reference impedance/Calibration value
U	Below range limit

### 2.3.4.5 Group of Addressed and Universal Instructions

#### 2.3.4.5.1 Remote/Local

If the URE receives its listener address from a controller, it will switch over to the remote state in accordance with the standard and remain in this state even after completion of the data transfer. All the operating controls on the front panel are disabled in the remote state but displays and the illumination of the keys remain operative. The analog output also remains operative. The remote state is indicated by REM and by

LIS (URE addressed as a listener),  
 TAL (URE addressed as a talker), or  
 SRQ (URE sends Service Request)

lighting up. This permits the state of the interface function to be checked, which is particularly useful for testing purposes. If the instruction GTL (Go to Local) is received, or if the LOCAL key is pressed, the URE switches to the local state and can then be set manually.

The indication REM disappears; LIS and TAL remain operative.

If the key LOCAL is not inhibited (see below), it has priority over the IEC bus. This means that a transfer to the bus can be interrupted by LOCAL. With the URE in TALK mode, activating the key LOCAL before sending the delimiter

can even block the IEC bus. The key LOCAL can be blocked by the controller with the command LLO (Local Lockout).

For the change of status remote - local - remote the settings

Q0, Q1  
N0, N1  
W0 ... W8  
V0 ... V2

are retained.

#### 2.3.4.5.2 Device Clear

If the controller sends the universal instruction DCL (Device Clear) or the addressed instruction SDC (Selected Device Clear), the URE assumes its basic setting (see section 2.3.3.8). The basic setting is also activated on switch-on of the URE or if the IEC-bus instruction C1 is issued.

#### 2.3.4.5.3 Device Trigger

On receiving the addressed instruction GET (Group Execute Trigger), the URE starts immediately a measurement at the selected setting. This trigger instruction corresponds to the device trigger instruction X1 (see section 2.3.4.3.4).

#### 2.3.4.5.4 Service Request

Setting the SRQ (Service Request) line enables the URE to request service from the controller. This proves useful when the end of a measurement, an autocalibration, or a fault is to be communicated to the controller. The instructions Q0 and Q1 (Table 2-7) permit the interface to be set accordingly.

If the controller executes a Serial Poll after having received a Service Request, it can determine the device status that caused the issue of the Service Request by decoding the status byte (Fig. 2-9 and Table 2-13).

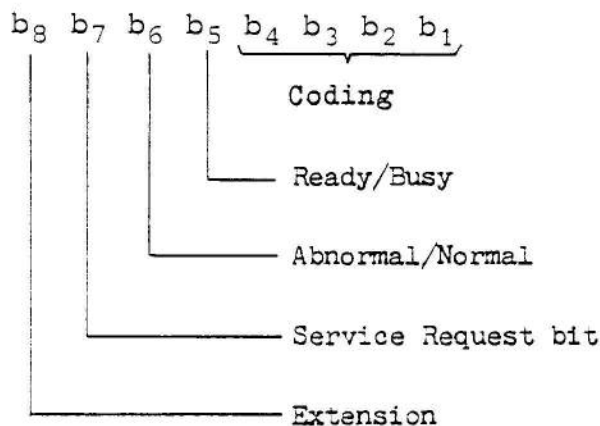

Fig. 2-9 Status byte

Table 2.13 Status byte coding

Device status	Status byte	Decimal equivalent
End of measurement	L H L H L L L L	80
End of autocalibration without error	L H L H L L L H	81
Compensation time		
∅ ms	L H L H L L H L	82
5 ms	L H L H L L H H	83
10 ms	L H L H L H L L	84
End of autocalibration with error	L H H H L L L H	113
Syntax error in IEC-bus instruction	L H H L L L L L	96
Incorrect input data	L H H L L L H L	98
Talker address without previous trigger	L H H L L L H H	99
Improper function of hardware	L H H L L H L L	100

#### 2.3.4.5.5 Notes for CEM Computer Users

Since the CEM computer processes INPUT commands asynchronously after 64 ms (version 82), errors may well occur in the data transfer from URE to the controller. If the URE is transferring the 1<sup>st</sup> character while the computer stops the INPUT, the URE continues with the second character for the next TALK address so that the string read in to the computer does not contain the first character. For this reason, the URE can be programmed with the instruction H1 such that the transfer begins with the first character on TALK addressing. The instruction H1 should only be applied to the CEM computer so that transfer of part of a string remains possible for other controllers. H1 can be made inactive using the instructions

C1 (Basic setting)

DCL (Device clear)

SDC (Selected device clear)

as well as by switching off and on the URE.

When using CEM computers (version 1982) it should also be noted that the URE uses delimiter CR (instruction W1).

Table 2-14 Setting the device address

ASCII character		Binary address					Decimal equivalent
Listener address	Talker address	A5	A4	A3	A2	A1	
(SPACE)	@	L	L	L	L	L	0
!	A	L	L	L	L	H	1
"	B	L	L	L	H	L	2
#	C	L	L	L	H	H	3
\$	D	L	L	H	L	L	4
%	E	L	L	H	L	H	5
&	F	L	L	H	H	L	6
'	G	L	L	H	H	H	7 <sup>+) )</sup>
(	H	L	H	L	L	L	8
)	I	L	H	L	L	H	9
*	J	L	H	L	H	L	10
+	K	L	H	L	H	H	11
,	L	L	H	H	L	L	12
-	M	L	H	H	L	H	13
.	N	L	H	H	H	L	14
/	O	L	H	H	H	H	15
0	P	H	L	L	L	L	16
1	Q	H	L	L	L	H	17
2	R	H	L	L	H	L	18
3	S	H	L	L	H	H	19
4	T	H	L	H	L	L	20
5	U	H	L	H	L	H	21
6	V	H	L	H	H	L	22
7	W	H	L	H	H	H	23
8	X	H	H	L	L	L	24
9	Y	H	H	L	L	H	25
:	Z	H	H	L	H	L	26
;	[	H	H	L	H	H	27
<	]	H	H	H	L	L	28
=	^	H	H	H	L	H	29
>		H	H	H	H	L	30

+ ) Factory-set



Table 2-15 ISO 7-bit code (ASCII code)

(SENT AND RECEIVED WITH ATN=1)

Row	Column	b <sub>7</sub>	b <sub>6</sub>	b <sub>5</sub>	b <sub>4</sub>	b <sub>3</sub>	b <sub>2</sub>	b <sub>1</sub>	MSG	0 0 0	0 0 1	0 1 0	0 1 1	1 0 0	1 0 1	1 1 0	1 1 1	MSG						
0	0	0	0	0	0	0	0	0	NUL		DLE	SP	0	␣	P	,	7							
1	1	0	0	1	1	0	0	1	SOH	GTL	DC1	!	1	A	Q	;	8							
2	2	0	0	1	0	1	0	0	STX		DC2	"	2	B	R	?	9							
3	3	0	0	1	1	0	1	0	ETX		DC3	#	3	C	S	0	0							
4	4	0	1	0	0	0	0	0	EOT	SDC	DC4	\$	4	D	T	1	1							
5	5	0	1	0	1	0	1	0	ENQ	PPC <sup>③</sup>	NAK	%	5	E	U	2	2							
6	6	0	1	1	0	0	0	0	ACK		SYN	&	6	F	V	3	3							
7	7	0	1	1	1	0	0	0	BEL		ETB	'	7	G	W	4	4							
8	8	1	0	0	0	0	0	0	BS	GET	CAN	(	8	H	X	5	5							
9	9	1	0	0	1	0	0	0	HT	TCT	EM	)	9	I	Y	6	6							
10	10	1	0	1	0	0	0	0	NL		SUB	*	10	J	Z	7	7							
11	11	1	0	1	1	0	0	0	VT	ESC		+	11	K	[	8	8							
12	12	1	1	0	0	0	0	0	FF	FS		,	12	L	\	9	9							
13	13	1	1	0	1	0	0	0	CR	GS		-	13	M	]	0	0							
14	14	1	1	1	0	0	0	0	SO	RS		.	14	N	^	1	1							
15	15	1	1	1	1	0	0	0	SI	US		/	15	O	_	2	2							
										ADDRESSSED COMMAND GROUP (ACG)			UNIVERSAL COMMAND GROUP (UCG)			LISTEN ADDRESS GROUP (LAG)			TALK ADDRESS GROUP (TAG)			SECONDARY COMMAND GROUP (SCG)		

- NOTES:
- ① MSG = INTERFACE MESSAGE
  - ② b<sub>1</sub> = D101...b<sub>7</sub> = D107
  - ③ REQUIRES SECONDARY COMMAND
  - ④ DENSE SUBSET (COLUMN 2 THROUGH 5)

#### 2.3.4.6 Data Output in Talk Only Mode

For the printout of measurement data without an IEC-bus controller, the data can be output via the IEC-bus connector to a Listen Only device having an IEC-625 interface. For this, the device used, for example a printer, is set to LISTEN ONLY and the URE to TALK ONLY (see section 2.3.4.1).

In this operating mode, the URE is operated from the front panel and any of the data displayed can be output to the Listen Only device by pressing the LOCAL key. The coding is described in section 2.3.4.4. The delimiter setting is fixed, each output being terminated by CR + NL (Carriage Return + New Line).

#### 2.3.4.7 Retrofitting the IEC-bus Option

The IEC-bus option retrofitting kit consists of the following items (see Figs. 2-11 and 2-12):

- 1 ea IEC interface 7
- 1 ea IEC board 4
- 2 ea locking screw 2
- 2 ea lock washer 3
- 1 ea light bar module 10.

For mounting the IEC-bus option, refer to Figs. 2-11 and 2-12. Performance checking is described in section 3....

- Loosen the four Phillips-head screws holding the top and bottom covers of the URE and remove covers.
- Press out the plastic cover of the IEC-bus connector opening on the rear panel 1.
- Fasten the IEC board 4 to the rear panel by means of the two locking screws 2 and the two lock washers 3.
- Connect the two flat cables 8 to the IEC interface 7.
- Mount the IEC interface 7 on the computer board 5 by inserting the three latching plugs in the holes provided and connect the female multi-way connector 6.
- Remove the display filter 9 after loosening the two Phillips-head screws.

- Insert the light bar module 10 into the socket provided for this purpose. The mounting position is irrelevant but make sure that the module is flush with the display window.

### 2.3.5 Analog Output

The Analog Output Option permits a DC voltage proportional to the indicated value to be output. This voltage is produced by means of a 12-bit D/A converter at the display rate, i.e. when the URE is operated via the IEC bus the voltage value can only be renewed by initiating a measurement. The operating range of the output voltage is -2 to +2 V with a resolution of 1 mV ( $Z_{out} = 100 \Omega$ ). The output is referred to the earth conductor, not to the outer contact of the input socket.

The relationship between the output voltage and the display is given by the following equation:

$$\frac{\text{Output voltage}}{V} = \frac{\text{Displayed value without decimal point}}{10\ 000}$$

Example:

Display	Output voltage
11.500 V	+1.150 V
-37.25 dBV	-0.372 V
1.13%	+0.011 V

When changing over to the second key function or when the reference voltage and reference impedance are displayed, there is still a voltage output corresponding to the measured value.

The fact that the output voltage is related to the displayed value and not to the measured voltage offers interesting possibilities:

Lin. output, absolute	(V)
Lin. output, normalized	(V/REF, Δ%)
Lin. output, with/without offset	(ΔV, Δ%)
Log. output	(dBV, dBm)
Log. output, with/without offset	(ΔdB).

It should be borne in mind that output voltage jumps may be caused if the number of display digits is changed due to range switching or change of display format. Range switching caused by voltages below the range limit

can be avoided by means of the RANGE HOLD key or by direct setting by means of service function 2 (see section 2.3.3.6). However, if the test voltage changes are considerable, the display should be switched over to dBV, dBm,  $\Delta$ dB or  $\Delta\%$ . In the logarithmic display mode, the resolution is always 0.01 dB, i.e. the output voltage changes by 10 mV if the measured value changes by 1 dB. The indicating range from -199.99 to +199.99 (dBV, dBm,  $\Delta$ dB) covers the entire measurement range of the URE. In the indicating mode  $\Delta\%$ , the resolution is constant within the range from -199.99 to +199.99% and is 0.01%, so that the output voltage over this range changes by 10 mV if the measured value changes by 1%.

#### 2.3.5.1 Retrofitting the Analog Output Option

The analog output option retrofitting kit consists of the following items (see Fig. 2.13):

- 1 ea DC output board 9
- 1 ea connecting cable 10
- 2 ea socket including accessories 1, 2, 3, 4, 5, 6.

For mounting the analog output option, refer to Fig. 2-13. Readjustment of the voltmeter is not required. For performance checking see section 3....

- Remove top cover of the URE after loosening four Phillips-head screws.
- Press out the two plugs in the socket openings.
- Mount the two sockets 1. Observe correct sequence when assembling the individual parts.
- Mount the DC output board 9 on the computer board 7 by inserting the four latching plugs in the holes provided and connect the female multi-way connector 8.
- Plug the connecting cable 10 onto ST10. Be careful to match the contacts; Pin 2 of ST10 is marked.
- Solder the free ends of the connecting cable 10 to the two sockets 1. Observe colour coding.

### 3. Maintenance

#### 3.1 Measuring Equipment Required

See Table 3-16 in Appendix.

#### 3.2 Check of Voltmeter Operation

RMS Voltmeter URE is specified for operation in the temperature range  $+5^{\circ}$  to  $+45^{\circ}\text{C}$  (IEC-359 Applications Class 1).

The tolerances for the measured values given in this section apply to the limited temperature range  $+15^{\circ}$  to  $+30^{\circ}\text{C}$  as laid down in section 1 of URE Data Sheet.

The test procedures of this section apply for the entire operating temperature range of the URE and may be used, if necessary, with the extended tolerances given in the Data Sheet.

The AC supply voltage must lie within  $\pm 10\%$  of the nominal value to which the instrument has been set (section 2.2.3).

Except when otherwise specified, the instrument settings are made manually (i.e. not by means of an IEC-bus controller).

| To check the nominal values of the URE a minimum warm-up time  
| of 30 minutes must be allowed for.

#### 3.2.1 Check of Display and Key Functions

##### 3.2.1.1 Displays

When service function 0 is called (section 2.3.3.7.2), all indications, including the key illumination, must light (Fig. 2-9). The return to the measurement mode occurs automatically after 3 seconds.

Note:

The illuminated display for remote status is included in the URE only when the IEC-bus option is built-in.

##### 3.2.1.2 Keys

The proper functioning of all keys must be checked.

Initial URE settings: SHIFT key not activated

Key Input	Function	Indication
AC	AC measurement	AC key lights
DC	DC measurement	DC key lights
AC+DC	AC+DC measurement	AC+DC key lights
RCL Z	Display of stored reference impedance	RCL Z key lights, other key illumination is off
RCL REF	Display of stored reference voltage	RCL REF $\Delta$ key lights, other key illumination is off
RANGE HOLD	Automatic range selection disabled	RANGE HOLD key lights
FAST $f > 100$ Hz	Switch-over of measuring speed	FAST key lights
LOW PASS	Measuring bandwidth limited	LOW PASS key lights, LP/kHz display lights
SELECT	Switch-in of low-pass cutoff frequency	Illuminated display: 4 $\rightarrow$ 20 or 20 $\rightarrow$ 100 or 100 $\rightarrow$ 4
dBV	dBV indication	dBV in display area lights
dBm (Z)	dBm indication	dBm in display area lights
V	Voltage indication	mV or V in display area lights
$\Delta$ V	Relative voltage indication	mV or V and $\Delta$ in display area light
$\Delta\%$	$\%$ indication	$\%$ and $\Delta$ in display area light
$\Delta$ dB	dB indication	dB and $\Delta$ in display area light
V/REF	Relative indication	$\Delta$ in display area lights
SHIFT	Switch-over to the second functions	SHIFT key lights, other key illumination is off
STO	Storage of reference voltage and impedance, return to measuring function	SHIFT key illumination switched off

### 3.2.2 Check of AC Measurement Characteristics

The test setups are shown in Figs. 3-1, 3-2 and 3-3 at end of this section.

#### 3.2.2.1 Error Limits in Voltage Measurements at Lower Frequencies

URE settings:

Operating mode: AC

Display mode: V

Filters: LCW PASS out, SLOW (FAST out)

Procedure A, For measured voltages  $\geq 30$  mV, setup of Fig. 3-1:

- Adjust AC voltage and frequency at the AC calibrator and apply to URE test terminal.
- Check the URE indicated values according to Table 3-1.

Procedure B, For measured voltages  $\leq 30$  mV, setup of Fig. 3-2:

- Set attenuation box to 20 dB.
- At a frequency of 10 kHz, adjust the output voltage of the signal generator so that the URE indication has the same value that it has when the AC calibrator in procedure A is set to 100 mV at 10 kHz.
- Keep signal-generator output level unchanged. Check by maintaining the power-meter DC voltage output constant, as monitored by the digital voltmeter.
- Check the URE indications for the specified settings of the attenuation box as given in Table 3-2.

Table 3-1

URE range selection	Test voltage and frequency		URE measurement range	URE indication	
				Nominal value	Permitted deviation
Automatic (RANGE HOLD off)	Set on AC calibrator		100 mV	80.00 mV	+2% ±0.5% ±0.5% ±0.5% ±0.5%
	80 mV	10 Hz			
		100 Hz			
		1 kHz			
		10 kHz			
		100 kHz			
RANGE HOLD	80 mV	100 kHz	100 mV	100.00 mV	±0.5% +)
	100 mV	10 kHz	100 mV		
Automatic	200 mV	10 kHz	300 mV	200.0 mV	±0.5% +)
	316.2 mV	10 kHz	300 mV	316.2 mV	±0.5% +)
	800 mV	100 Hz	1 V	.8000 V	±0.5%
		1 kHz		.8000 V	±0.5%
		10 kHz		.8000 V	±0.5%
		100 kHz		.8000 V	±0.5%
RANGE HOLD	800 mV	100 kHz	1 V	1.0000 V	±0.5% +)
	1 V	10 kHz	1 V		
Automatic	2 V	10 kHz	3 V	2.000 V	±0.5%
RANGE HOLD	2 V	10 kHz	3 V	3.162 V	±0.5%
	3.162 V	10 kHz	3 V		
Automatic	8 V	10 kHz	10 V	8.000 V	±0.5%
RANGE HOLD	8 V	10 kHz	10 V	10.000 V	±0.5%
	10 V	10 kHz	10 V		
Automatic	20 V	10 kHz	30 V	20.00 V	±0.5%
	80 V	100 Hz	100 V	80.00 V	±0.5%
		1 kHz		80.00 V	±0.5%
		10 kHz		80.00 V	±0.5%
		100 kHz		80.00 V	±0.5%
		20 kHz	300 V	300.0 V	±0.5%

+ ) The indicated voltage serves as reference value for wideband voltage measurements up to 20 MHz in the particular measurement range.



Table 3-2

URE range selection	Test voltage and frequency		Attenuator box setting	URE measurement range	URE indication	
					Nominal value	Permitted deviation
Automatic	Set on signal generator 80 mV 10 kHz		20 dB	100 mV		
RANGE HOLD	100 mV 10 kHz		20 dB	100 mV	100.00 mV	$\pm 0.5\%$
	Adjust to reference value obtained in previous calibration (see note under Table 3-1)					
Automatic	0.1 mV 10 kHz	80 dB	1 mV	.100 mV	$\pm(0.5\% + 15 \mu V)$	
	0.3162 mV 10 kHz	70 dB	1 mV	.316 mV	$\pm(0.5\% + 4 \mu V)$	
	1 mV 10 kHz	60 dB	1 mV	1.000 mV	$\pm(0.5\% + 1 \mu V)$	
	3.162 mV 10 kHz	50 dB	3 mV	3.162 mV	$\pm 0.5\%$	
	10 mV 10 kHz	40 dB	10 mV	10.000 mV	$\pm 0.5\%$	
	31.62 mV 10 kHz	30 dB	30 mV	31.62 mV	$\pm 0.5\%$	

### 3.2.2.2 Error Limits in Voltage Measurements at Higher Frequencies

URE settings:

Operating mode: AC

Display mode: V

Filters: LOW PASS out, SLOW in (= FAST out)

Measurement range: Set by use of service function 2 (section 2.3.3.7.2)  
with entry of range number as given in Table 3-3.

Test Procedure A, For measured voltages  $\leq 1$  V  
Use setup of Fig. 3-2.

- Set attenuation box to value given in Table 3-3.
- At 10 kHz, adjust the signal-generator output level so that the URE indication has the reference value (identified in section 3.2.2.1 by \*) for the URE voltage measurement range involved.
- Keep the signal-generator output level unchanged. Check by maintaining the power-meter DC output voltage constant, as monitored on the digital voltmeter.
- Check the URE indication against the value in Table 3-3.

Test Procedure B, For measured voltages from 1 V to 10 V  
Use setup of Fig. 3-3.

- Set the attenuator or the 10 dB power attenuator of the test setup to the values given in Table 3-3.
- Adjust the signal-generator output level at 10 kHz so that the URE indication has the reference value (as given in section 3.2.2.1 for the measurement range involved).
- Keep DC output voltage of power meter at the 10-kHz value for all frequencies given in Table 3-3.
- Check the URE indication against the value in Table 3-3.

Table 3-3

URE range number setting	Test voltage and frequency		Attenuator setting	URE measurement range	URE indication	
					Nominal value	Permitted deviation
05	Signal generator setting		Attenuator setting			
	100 mV 10 kHz		20 dB	100 mV	100.00 mV	$\pm 0.5\%$
	Adjust URE indication to reference value obtained in calibration.					
	100 mV 200 kHz		20 dB	100 mV	100.00 mV	+0.7%
	1 MHz				100.00 mV	$\pm 0.7\%$
	3 MHz				100.00 mV	$\pm 1.5\%$
10 MHz				100.00 mV	$\pm 4\%$	
20 MHz				100.00 mV	$\pm 10\%$ typ.	
04	31.62 mV 10 kHz		30 dB	30 mV	31.62 mV	+0.5%
	10 MHz				31.62 mV	$\pm 4\%$
03	10 mV 10 kHz		40 dB	10 mV	10.000 mV	+0.5%
	10 MHz				10.000 mV	$\pm 4\%$
02	3.162 mV 10 kHz		50 dB	3 mV	3.162 mV	+0.5%
	200 kHz			3 mV	3.162 mV	$\pm 0.7\%$
	1 MHz				3.162 mV	$\pm 0.7\%$
	3 MHz				3.162 mV	$\pm 3\%$
	20 MHz				3.162 mV	$\pm 15\%$ typ.
	Adjust URE indication to reference value obtained in calibration.					
01	1 mV 10 kHz			1 mV	1.000 mV	$+(0.5\% + 1 \mu\text{V})$
	10 MHz				1.000 mV	$\pm 7\%$
06	316.2 mV 10 kHz		10 dB	300 mV	316.2 mV	+0.5%
	Adjust URE indication to reference value obtained in calibration.					
	316.2 mV 10 MHz		10 dB	300 mV	316.2 mV	$\pm 4\%$
07	1 V 10 kHz		0 dB	1 V	1.0000 V	$\pm 0.5\%$
	Adjust URE indication to reference value obtained in calibration.					
	1 V 200 kHz		0 dB	1 V	1.0000 V	+0.7%
	1 MHz				1.0000 V	$\pm 0.7\%$
	3 MHz				1.0000 V	$\pm 1.5\%$
	10 MHz				1.0000 V	$\pm 4\%$
20 MHz				1.0000 V	$\pm 10\%$ typ.	

URE range number setting	Test voltage and frequency		URE measurement range	URE indication	
				Nominal value	Permitted deviation
08	Signal generator setting	Attenuator setting			
	3.162 V 10 kHz	10 dB	3 V	3.162 V	+0.5%
	Adjust URE indication to reference value obtained in calibration.				
	3.162 V 10 MHz	10 dB (3 W)	3 V	3.162 V	+4%
09	10 V 10 kHz	10 dB (3 W) +10 dB attenuator	10 V	10.000 V	+0.5%
	Adjust URE indication to reference value obtained in calibration.				
	10 V 1 MHz	10 dB (3 W) +10 dB attenuator	10 V	10.000 V	+0.7%
	3 MHz 10 MHz			10.000 V 10.000 V	+1.5% +4%
10	10 V 10 kHz		30 V	10.00 V	+0.5%
	1 MHz			10.00 V	+0.7%
	10 MHz			10.00 V	+4%

### 3.2.2.3 Switchable Low-pass Filter

URE settings:

Operating mode: AC

Display modes: V and  $\Delta$ dB

Filters: SLOW (FAST out)

Measurement range: Set 100 mV range by use of service function 2 (section 2.3.3.7.2) with entry of range number 05.

Test procedure: Test setup as in Fig. 3-1.

- Apply a sinewave signal of the required frequency from the AC calibrator to the URE.
- Switch in the low-pass filter and set cutoff frequency specified in Table 3-4.
- Check the URE indication against the value in Table 3-4.

Table 3-4

URE settings	Test voltage and frequency	URE indication		Illuminated display field
		Nominal value	Permitted deviation	
LOW PASS out	100 mV 100 Hz	100.00 mV	+0.5% +)	
LOW PASS in SELECT 4 kHz	100 mV 100 Hz	100.00 mV	+0.5% +)	LP/kHz 4 Store indicated value as reference, with SHIFT, STO.
Display mode ΔdB	100 mV 100 Hz 1 kHz 4 kHz 8 kHz	0.00 dB 0.00 dB -3.00 dB -12.00 dB	+0.02 dB ±0.04 dB typ. ±0.5 dB ±1 dB typ.	LP/kHz 4
SELECT 20 kHz, Display mode V	100 mV 100 Hz	100.00 mV	+0.5% +)	LP/kHz 20 Store indicated value as reference, with SHIFT, STO.
Display mode ΔdB	100 mV 100 Hz 4 kHz 20 kHz 40 kHz	0.00 dB 0.00 dB -3.00 dB -12.00 dB	+0.02 dB ±0.04 dB typ. ±0.5 dB ±1 dB typ.	
SELECT 100 kHz Display mode V	100 mV 100 Hz	100.00 mV	+0.5% +)	LP/kHz 100 Store indicated value as reference, with SHIFT, STO.
Display mode ΔdB	100 mV 100 Hz 20 kHz 100 kHz 200 kHz	0.00 dB 0.00 dB -3.00 dB -12.00 dB	+0.02 dB ±0.04 dB typ. ±0.5 dB ±1 dB typ.	LP/kHz 100

+ ) Typical deviation of the four settings from one another < 0.05%.

#### 3.2.2.4 Speed Selection of AC Measurements

Check of switching characteristics of the lower cutoff frequencies and associated filtering of the rectified AC voltage.

URE settings:

Operating mode: AC

Display mode: V

Measurement range: Set 100 mV range by use of service function 2 (section 2.3.3.7.2) with entry of range number 05.

Test Procedure: Test setup of Fig. 3-1:

- Set the AC calibrator to the required frequency and sinusoidal voltage and apply signal to URE input.
- Select measuring speeds as given in Table 3-5.
- Check the URE indications against values given in Table 3-5.

Table 3-5

URE setting	Test voltage and frequency		URE indication		Deviation range
			Nominal value	Permitted deviation	
SLOW (= FAST out)	100 mV	10 Hz	100.00 mV	+2%	+2 digits
		100 Hz	100.00 mV	+0.5%	
		10 kHz	100.00 mV	+0.5% +)	
FAST		100 Hz	100.00 mV	+1%	+1 digit +10 digits typ.
		50 Hz	100.00 mV		
		1 kHz	100.00 mV	+0.5%	
		10 kHz	100.00 mV	+0.5% +)	
SUPERFAST (set manually with use of service function 3)		1 kHz	100.00 mV	+1%	+1 digit +10 digits typ.
		500 Hz	100.00 mV		
		10 kHz	100.00 mV	+0.5% +)	

+)  
Typical deviation of the three settings from one another < 0.05%.

### 3.2.2.5 Measurement Rectifier

#### 3.2.2.5.1 Linearity of Measured Values

URE settings:

Operating mode: AC  
Display mode: V  
Filters: LOW PASS out, FAST  
Measurement range: Set 1 V range by use of service function 2 (section 2.3.3.7.2) and entry of range number 07.

Test procedure: Test setup of Fig. 3-1

- Set the AC calibrator to a frequency of 10 kHz and the required sinusoidal voltage to 1 V and apply the signal to URE input.

Indication on URE: 1.0000 V  $\pm$  0.5 %

- Store indicated value by first pressing the SHIFT key and subsequently the STO key.
- Select the relative function V/REF on the URE
- Change input voltage of URE and check the linearity of the measured values against Table 3-6.

Table 3-6

Test voltage (at 10 kHz)	URE indication	
	Nominal value	Permitted deviation
1.1 V	1.1000 V	$\pm$ 0.1%
1.0 V	1.0000 V	$\pm$ 0.01% (reference value)
0.9 V	.9000 V	$\pm$ 0.1%
0.8 V	.8000 V	$\pm$ 0.1%
0.7 V	.7000 V	$\pm$ 0.1%
0.6 V	.6000 V	$\pm$ 0.1%
0.5 V	.5000 V	$\pm$ 0.1%
0.4 V	.4000 V	$\pm$ 0.1%
0.3 V	.3000 V <sup>+) )</sup>	$\pm$ 0.1% typ.
0.2 V	.2000 V <sup>+) )</sup>	$\pm$ 0.2% typ.
0.1 V	.1000 V <sup>+) )</sup>	$\pm$ 0.5% typ.

<sup>+) )</sup> Blinking of the rightmost digit signifies that the measurement was not made with the optimal measurement range (measured voltage below lower limit of measurement range).

### 3.2.2.5.2 Error Limits in RMS Measurements

URE settings: As in section 3.2.2.5.1.

Test procedure: Test setup Fig. 3-4.

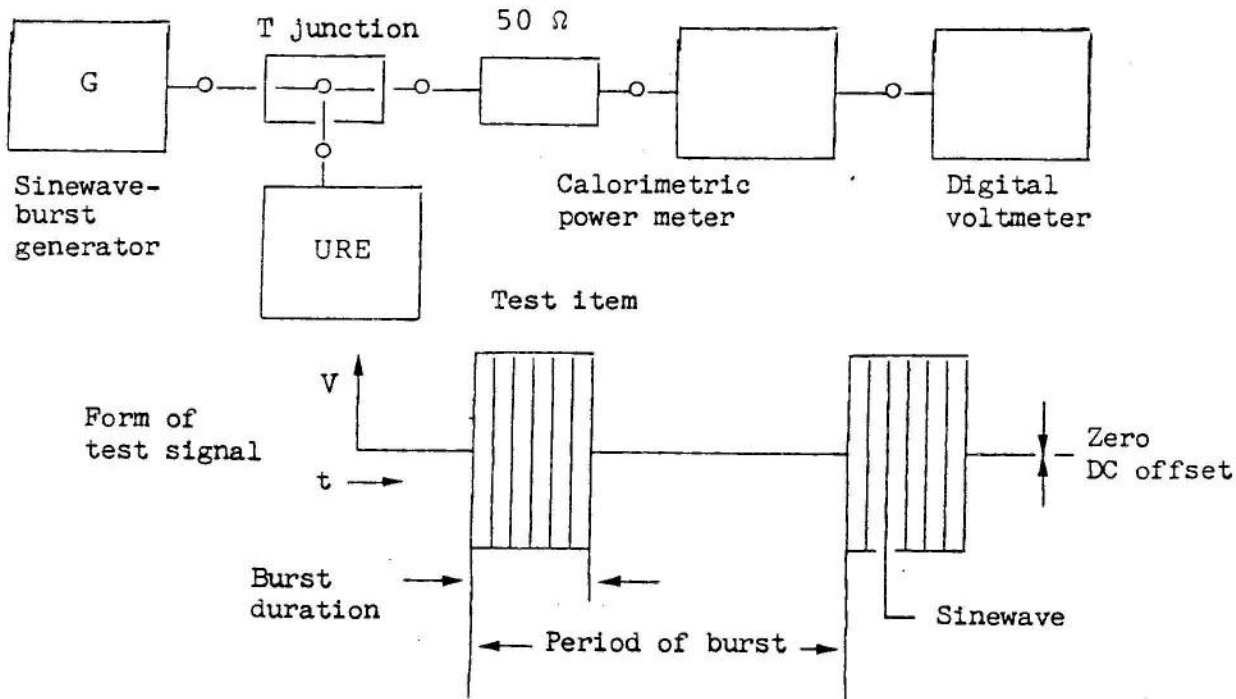

- Adjust the level of a continuous 10-kHz sinewave at the generator so that the URE indication is the same as that obtained with the 10-kHz, 1.1-V signal from the AC calibrator in the test of section 3.2.2.5.1. Note the value of the power-meter output as reference value for further measurements.
- Switch the generator to the burst output mode and set the burst frequency to 100 Hz. Set the burst duration to the value given in Table 3-7 (check with oscilloscope) and adjust the generator output level so that the digital voltmeter attains the reference value obtained in previous adjustment.
- Check the URE indication against the value in Table 3-7.



Table 3-7

Form of test signal	Crest factor Vp/Vrms	Test voltage Vrms	Nominal value	URE indication	
				Permitted absolute	deviation relative to sinewave
sinewave, continuous  +) +) Adjust to reference value of AC calibration.	$\sqrt{2}$	1.1 V	1.1000 V	$\pm 0.5\%$ +)	
sinewave bursts, burst duration: 5 ms	2	1.1 V	1.1000 V	$\pm 0.5\%$	$\pm 0.1\%$
sinewave bursts, burst duration: 2.2 ms	3	1.1 V	1.1000 V	$\pm 0.5\%$	$\pm 0.2\%$
sinewave bursts, burst duration: 0.8 ms	5	1.1 V	1.1000 V	$\pm 3.5\%$	$\pm 3\%$

### 3.2.3 Check of DC Measurement Characteristics

#### 3.2.3.1 Error Limits in DC Voltage Measurements

URE settings:

Operating mode: DC  
 Display mode: V  
 Filters: FAST  
 Measurement range: automatic (RANGE HOLD out)

Test Procedure: Test setup Fig. 3-5.

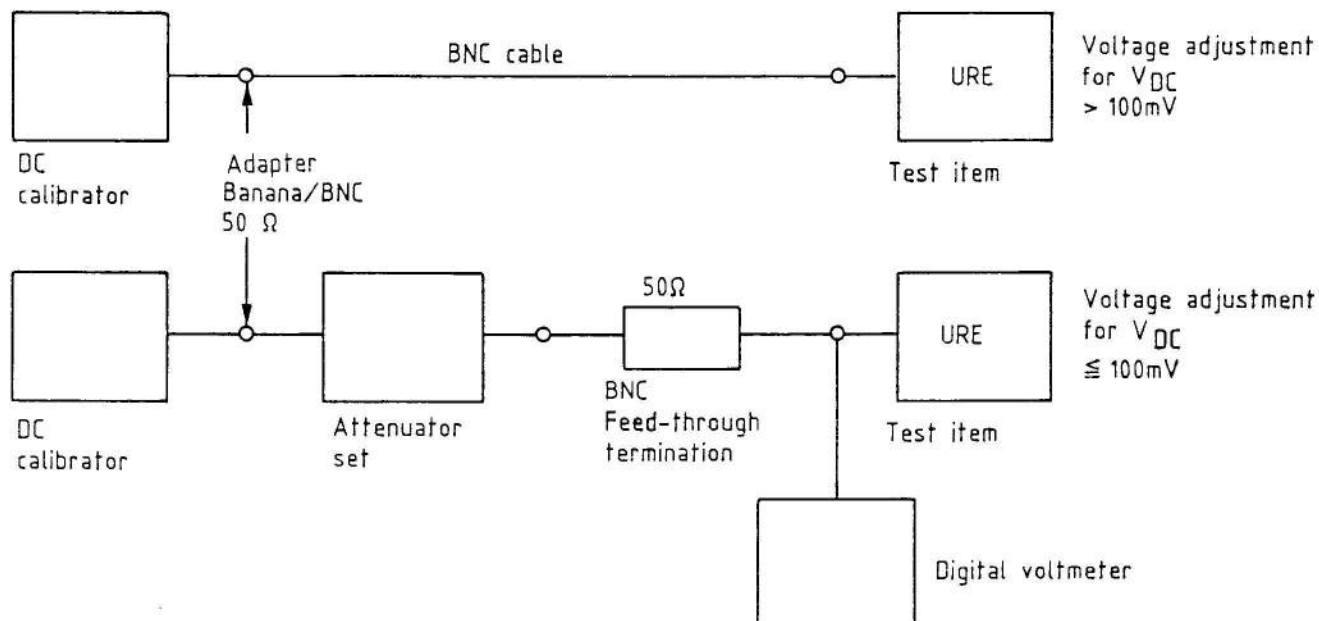

A) For test voltages  $\geq 100$  mV:

- Adjust DC-calibrator voltage and apply to URE input.
- Check the URE indications against values in Table 3-8.

B) For test voltages  $\leq 100$  mV:

- Insert attenuation box and 50 feed-through termination between DC calibrator and URE input.
- Set DC calibrator to 1 V in the 10-V range.
- Set the attenuation box to the value given in Table 3-8 and measure the URE input voltage with a digital voltmeter.
- Check the URE indication against the value in Table 3-8.

Table 3-8

Output voltage of DC calibrator	Attenuator setting	DC test voltage	URE measurement range	URE indication	
				Nominal value	Permitted deviation
-	-	0 V only 50 $\Omega$ termination at URE	10 mV	.000 mV	<u>+10</u> digits
approx. 0.8 V	40 dB	8 mV	10 mV	8.000 mV	+(0.1% + 10 digits)
Set DC calibrator to nominal value of input voltage.					
80 mV	-	80 mV	100 mV	80.00 mV	+(0.1% + 10 digits)
0.8 V	-	0.8 V	1 V	.8000 V	+(0.1% + 10 digits)
8 V	-	8 V	10 V	8.000 V	+(0.1% + 10 digits)
80 V	-	80 V	100 V	80.00 V	+(0.1% + 10 digits)
300 V	-	300 V	300 V	300.0 V	+(0.1% + 10 digits)

### 3.2.3.2 Speed Selection of DC Measurements and AC Suppression

URE settings:

Operating mode: DC  
 Display mode: V  
 Measurement range: Set 1V range by use of service function 2  
 (section 2.3.3.7.2) with entry of range number 07.  
 Test procedure: Test setups as in Fig. 3-5 (section 3.2.3.1) and  
 Fig. 3-1.

- Set the DC-calibrator voltage and apply to URE test input.
- Set the measuring speed (filter) on the URE according to Table 3-9.
- Set sinewave to 0.3 V and the specified frequency on AC calibrator and apply to URE input.
- Check the URE indication against value in Table 3-9 for the given measuring speed and frequency.

Table 3-9

URE setting	Test signal	URE indication	
		Nominal value	Permitted deviation
SLOW	1 V DC	1.0000 V	+(0.1% + 10 digits)
	0.3 V 10 Hz	.0000 V	+100 digits +(2 digits typ. as ripple)
FAST	1 V DC	1.0000 V	+(0.1% + 10 digits)
	0.3 V 100 Hz	.0000 V	+10 digits +(2 digits typ. as ripple)
SUPERFAST (Set with use of service function 3)	1 V DC	1.0000 V	+(0.1% + 10 digits)
	0.3 V 1 kHz	.0000 V	+10 digits +(2 digits typ. as ripple)

### 3.2.4 Check of AC+DC Measurement Characteristics

URE settings:

Operating mode: AC+DC

Display mode: V

Filters: LOW PASS, SELECT 100 kHz, FAST

Test procedure: Test setup of Figs. 3-1 and 3-5 (section 3.2.3.1):

- Apply the signals from the AC and DC calibrators to URE input.
- Check the URE indication against the values in Table 3-10.

Table 3-10

URE range setting	Input		URE indication	
			Nominal value	Permitted deviation
automatic (RANGE HOLD out)	1 V	10 kHz	1.0000 V	+ (0.5% +10 digits)
RANGE HOLD	1 V 1 V	10 kHz DC	1.0000 V	+ (0.5% +10 digits)

### 3.2.5 Check of Input Impedance

The input impedance of the URE is 10 M $\Omega$   $\pm$ 2% for DC and low-frequency AC inputs.

The check is unnecessary if the error limits of the AC and DC measurement ranges lie within the permitted deviations.

Only the input capacitance is to be checked.

URE settings:

Operating mode: AC or AC+DC

Filters: FAST

Measurement range: Manually set by use of service function 2 with input of range number specified in Table 3-11.

Test procedure:

- Connect capacitance meter to URE input through a short, shielded lead.
- Set the URE voltage measuring range as given in Table 3-11.
- Measure the input capacitance.

Table 3-11

URE setting Range number	Measurement range	Input capacitance	
		Typical	Permitted
05	100 mV	35 pF	< 40 pF
07	1 V	32 pF	< 40 pF

3.2.6 Check of Relative Functions

See also sections 2.3.3.2.1, 2.3.3.2.2, 2.3.3.3 and 2.3.3.7.1.

3.2.6.1 Storage of Reference Value and Reference Impedance

URE settings:

SHIFT key: not activated  
 Operating mode: AC  
 Display mode: V  
 Filters: LOW PASS out, FAST  
 Measurement range: automatic (RANGE HOLD out)  
 Test procedure: Test setup of Fig. 3-1:

- Apply a 10-kHz, 0.5-V sinewave from the AC calibrator to URE input.
- Read off the URE indication.

Test:

The indicated value must be retained by operating the SHIFT key. By operating the STO key (second functions level), the retained value is to be stored as reference value for the relative functions  $\Delta V$ ,  $\Delta\%$ ,  $\Delta dB$  and  $V/REF$ .

- Switch off input voltage.
- Switch off the URE, wait at least ten seconds, and switch it on again. The stored reference value must be displayed when the REC REF $\Delta$  key is pressed.
- Check this several times as in the above step with varying wait times.

The storage of a test value and of a reference voltage or impedance entered via the keyboard is done in the same way, so that the method of checking the stored reference value is as before.

### 3.2.6.2 Check of dBm, dBV and $\Delta$ dB ranges

See also sections 2.3.3.2.1 and 2.3.3.2.2.

URE settings: See section 3.2.6.1.

Test procedure: Test setup of Fig. 3-1:

- Set a 10-kHz sinewave in the AC calibrator to the level given in Table 3-12 and apply to URE input.
- Check the URE indication against the value in Table 3-12.

Table 3-12

URE setting/entry	Test voltage	URE indication	
		Nominal value	Permitted deviation
Display mode V	Set to nominal URE indication	223.6 mV	-
Store 50 $\Omega$ as reference impedance (section 2.3.3.2.1)	(no change)	50. $\Omega$	
Display mode dBm		.00 dBm	-
Store 500 $\Omega$ as reference impedance		500. $\Omega$	-
Display mode dBm		20.00 dBm	$\pm 0.02$ dBm
Display mode V	Set to nominal URE indication	1.0000 V	-
Display mode dBV	(no change)	.00 dBV	$\pm 0.02$ dBV
Store measured value as reference, using SHIFT, STO.		.00 dBV	$\pm 0.02$ dB
Display mode $\Delta$ dB		.00 dB $\Delta$	$\pm 0.02$ dB
Store 1000 $\Omega$ as reference impedance		1000. $\Omega$	-
Display mode dBm		.00 dBm	$\pm 0.02$ dBm

### 3.2.7 Check of IEC-bus Interface

(with built-in IEC-bus option URE-B1)

See also section 2.3.4.

#### A) Setting of Address:

- Set device address 7 on the rear panel of URE (Table 2-14).
- When Service function 1 is called (section 2.3.3.7.2), the URE displays the device address in the form I E C 7. If the TALK ONLY mode is in use, IEC to appears in the display. In both cases, the URE returns to the measuring mode automatically after 2 seconds.

A changed address setting or a switchover from TALK-ONLY to NORMAL is read in either after the URE is switched off and then on again or when service function 1 is called again. The new setting or mode goes into effect only after this has been done.

#### B) Remote Control and Output of data via IEC-bus:

- Connect IEC-bus controller to URE via IEC-bus connector.
- Check all URE functions with the setting instructions according to section 2.3.4.
- Check the remote-status indication - REM, LIS, TAL, SRQ display.

#### C) Check of Local Function:

- Switch the URE to the remote status by Listener-addressing via the IEC-bus controller (without sending the LLO = local lockout).
- Check the remote-status display REM and LIS.  
When the LOCAL key of the URE is pressed, the URE must return to local (manual-operation).
- Check that the remote-status display (REM and LIS) goes out.

#### D) Check of TALK ONLY:

- Switch to TALK ONLY mode on rear panel of URE.
- Connect an IEC-bus compatible printer with LISTEN-ONLY selected to the URE via an IEC-bus cable.
- When the URE LOCAL key is pressed, the measured or reference value displayed on the URE is transferred via the IEC-bus interface and printed. Only one value may be output for every stroke of the Local key.

### 3.2.8 Check of Analog Output

(with built-in analog output option URE-B2)

URE settings:

Operating mode: DC

Display mode: V

Filters: FAST

Voltage measurement range: Set 1 V range by means of service function 2  
(section 2.3.3.7.2) and entry of range number 07.

Test procedure:

- Apply a DC voltage from the DC calibrator to URE test input.
- Set DC voltage level to nominal value given in Table 3-13.
- Connect a digital voltmeter to analog output of URE.
- Check analog voltage against value given in Table 3-13.

Table 3-13

Displayed value on URE	Voltage at analog output	
	Nominal value	Permitted deviation
1.0000 V	+1.0000 V	$\pm 2$ mV
-1.0000 V	-1.0000 V	$\pm 2$ mV
.0000 V	0 V	$\pm 2$ mV

### 3.3 Electrical Maintenance

No periodic electrical maintenance is required if the instrument is used in normal operating conditions. To insure full functioning, it is recommended that the unit be put through an autocalibration cycle now and then and that the lithium buffer battery and the reference voltages be checked every year or two.



### 3.3.1 Autocalibration

The URE is provided with a microprocessor-controlled self-calibration routine which permits an exact determination of the amplification characteristics, the voltage divider factors, the rectification characteristic of the rms-value rectifier and the analog-to-digital conversion factors. These parameter values are determined by comparison with reference DC voltages and from derived AC voltages. The parameters are evaluated by the microprocessor and then stored in a CMOS-RAM. When the URE is switched off, power for the CMOS-RAM is supplied by a buffer battery. Stored autocalibration values can thus be preserved for years.

Autocalibration can be initiated manually by use of service function 4 and via the IEC-bus.

With normal operation of the URE, frequent autocalibrations are not required, since the functional groups of the URE have a high inherent stability.

An autocalibration cycle is required

- to check the functioning of the analog and computer modules - for example for system use.
- after replacement of the buffer battery supplying the CMOS-RAM (see section 3.3.2).
- after every repair according to section 5.

Preconditions for performing an autocalibration:

- Ambient temperature  $+20^{\circ}$  to  $+25^{\circ}\text{C}$ ,
- URE fully warmed up to the operating temperature - switched on for at least 30 minutes.

If exceptionally, as in IEC-bus measurement systems, these conditions are deviated from, an increase in error limits is to be expected.

- Switch off input signal,
- Remove top cover after removing four Phillips-head screws.
- Pull off shorting link BU33 on the computer board.
- Call service function 4 (sections 2.3.3.7.2 and 2.3.4.3.5, Table 2-9).

The display C A L appears on the URE.

The autocalibration routine is completed in 20 seconds and the URE returns automatically to the measurement function.

- Replace shorting link BU33.

### 3.3.2 Check of Lithium Buffer Battery

A CMOS-RAM with buffer battery provides for the preservation of stored reference and calibration values when the URE is shut off.

The lithium battery has a life expectancy of typically 10 years. A check of the battery should be made every two years as follows:

- Switch of URE.
- Remove upper cover after loosening four Phillips-head screws.
- Measure the battery voltage with a digital voltmeter.  
Voltage of battery when new: 3.67 V nominal;  
Permissible voltage level:  $\geq 3.2$  V.

To replace the lithium battery,

- Cut the fastening strap and unsolder the connections.
- Install new battery (BA1 with fastening strap).
- Replace URE cover.
- Switch on URE.
- After 30 minutes warm-up, perform an autocalibration per section 3.3.1.

### 3.3.3 Check of Reference Voltages

Since the DC reference voltages used in the autocalibration determine to a large extent the error limits of the URE, they should be checked occasionally. This can conveniently be done when the lithium battery is checked, at intervals of one or two years.

The conditions for checking these voltages and possibly adjusting them are covered in sections 5.2.7.7 and 5.3.1.1.

### 3.4 Mechanical Maintenance

With normal operating conditions, the URE does not require any mechanical maintenance.

The following recommendations are, however, made:

If the front panel becomes soiled, it can be cleaned with a soft rag moistened with alcohol.

All screws, cables and plug-in units should be firmly seated. The connection of the outer conductor of the BNC socket with the ground of the analog circuit must be sound.

### 3.5 Storage

The URE can be stored for longer periods at temperatures between  $-25^{\circ}\text{C}$  and  $+70^{\circ}\text{C}$  (IEC-359 Application Class 1).

After prolonged storage at high humidities, the instrument should be dried out in the switched-off state at a temperature of about  $-40^{\circ}\text{C}$  before being placed in operation.

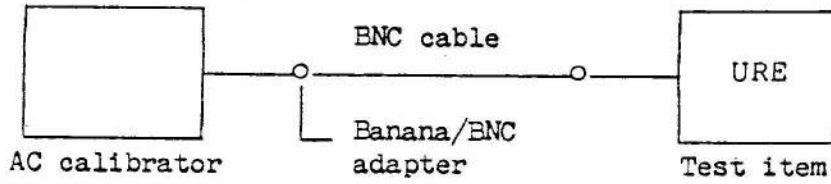

Fig. 3-1 AC test setup  
 Sinewave  $V_{eff}$ : 30 mV to 300 V  
 Frequency: 10 Hz to 100 kHz (1 MHz)

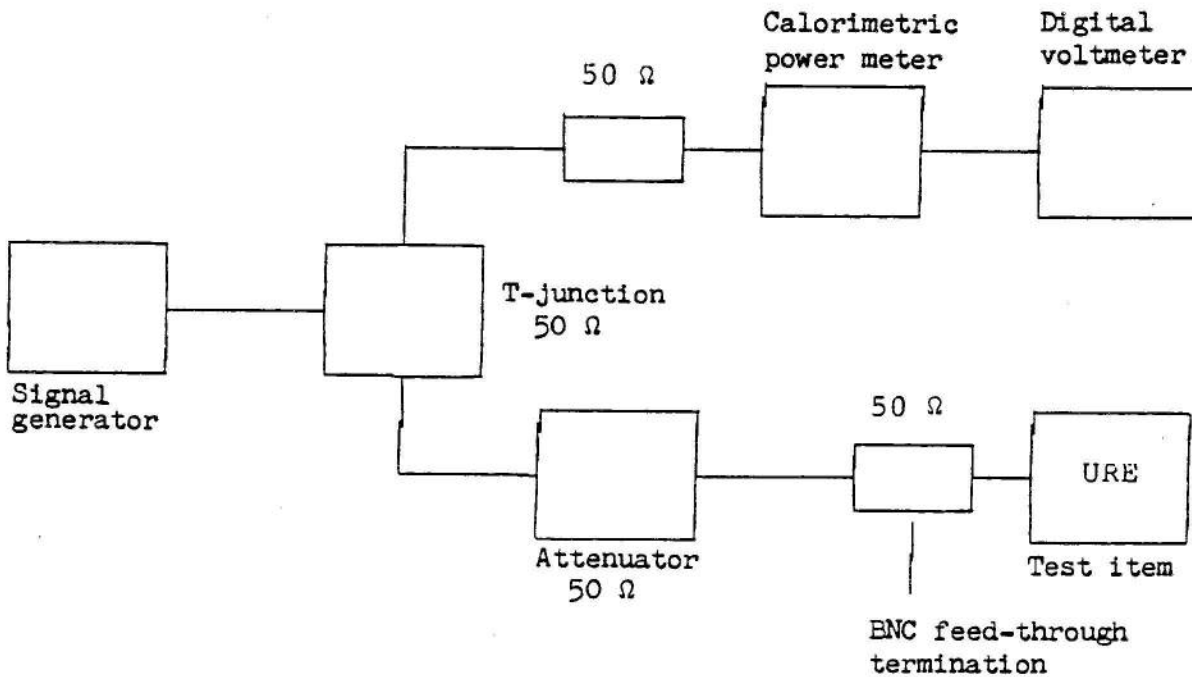

Fig. 3-2 AC test setup  
 Sinewave  $V_{eff}$ : 50  $\mu$ V to 1 V  
 Frequency: 10 kHz to 20 MHz

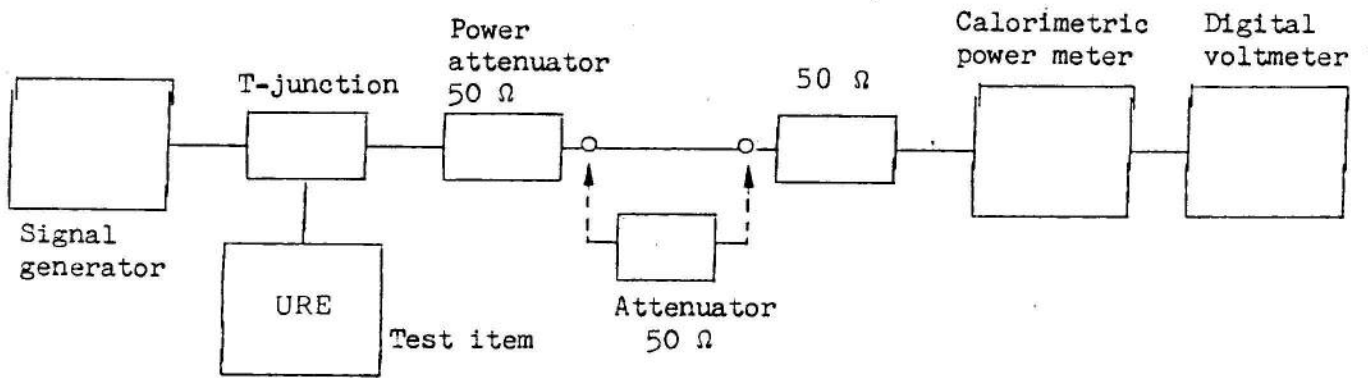

Fig. 3-3 AC test setup  
 Sinewave  $V_{\text{eff}}$ : 1 V to 10 V  
 Frequency: 10 kHz to 20 MHz

## 4. Functional Description

### 4.1 Overall Function

See Block diagram, Fig. 4-1, and Circuit diagram 342.1214 S.

RMS Voltmeter URE consists of the analog, digital and display/operation functional groups.

In the analog section, the input signal being measured is first processed according to its voltage level in input dividers, wideband amplifiers and range attenuation elements.

The DC and AC components of the input signal are then separately processed in the DC and AC measurement circuits. The AC circuit includes switchable low-pass filters for limiting the measurement bandwidth, switchable high-pass filters for eliminating the DC component and adapting the circuit to the measurement speed, a wideband push-pull amplifier, and a square-law measurement rectifier with switchable active filters.

In the DC circuit, the DC component is amplified and the AC component at the same time suppressed with switchable active filter.

The outputs of the two measurement circuits can be alternately switched into a microprocessor controlled A/D converter.

The URE can thus measure the value of the DC component alone, the RMS (or effective) value of the AC component, or the RMS value of the combined AC+DC signal.

The measurement circuits are calibrated automatically under microprocessor control by use of AC and DC reference voltages produced in the analog section.

All analog functions are remotely controllable via analog switches (FET, relays). By the transmission of all control signals over optical couplers and through the use of a separate power supply, the analog section is electrically isolated from the computer section and the instrument chassis.

In the digital section, the microprocessor system consisting of an 8085 microprocessor and peripheral ICs, controls the overall operation of the URE.

The functions performed are as follows:

- Output of the setting data for the analog section via RAM/Port IC 8155.
- Control of the analog-to-digital conversion by setting a 16-bit D/A converter in binary steps and interrogating a comparator.

- Computation of measurement, reference and calibration values and outputting to the display and/or IEC-bus IC.
- Storage and preservation of reference and calibration values in the CMOS-RAM.
- Output of display data (digits, illuminated fields, key illumination) and interrogation of the keys in time-multiplex operation via peripheral IC 8279.
- Input and output of data via the IEC-bus interface IC 8291A to establish Listener or Talker mode in IEC-bus systems.
- Control of a 12-bit D/A converter supplying the analog output.

The system program for the microprocessor is stored in four EPROMs of type 2732 with a total capacity of 16 K x 8 bits.

In addition to the microprocessor system, the digital board contains the power supply for the digital, display/operation and analog sections as well as the optocouplers for the voltage-isolated transmission of control and interrogation information to and from the analog part.

The IEC-bus and analog-output options are assigned to the digital section as functional plug-in units.

The display/operation section contains the keyboard and the LED display system with the 4-1/2-place digital display, the circularly arranged quasi-analog display, the illuminated displays and key illumination. The inputs to the displays and the interrogation of the keys are time-multiplexed via the computer board by the display-keyboard IC 8279 and microprocessor.

The power supply, consisting of the power switch, combination mains-connector, voltage-selector, fuse holder and power transformer is mounted on the rear panel.

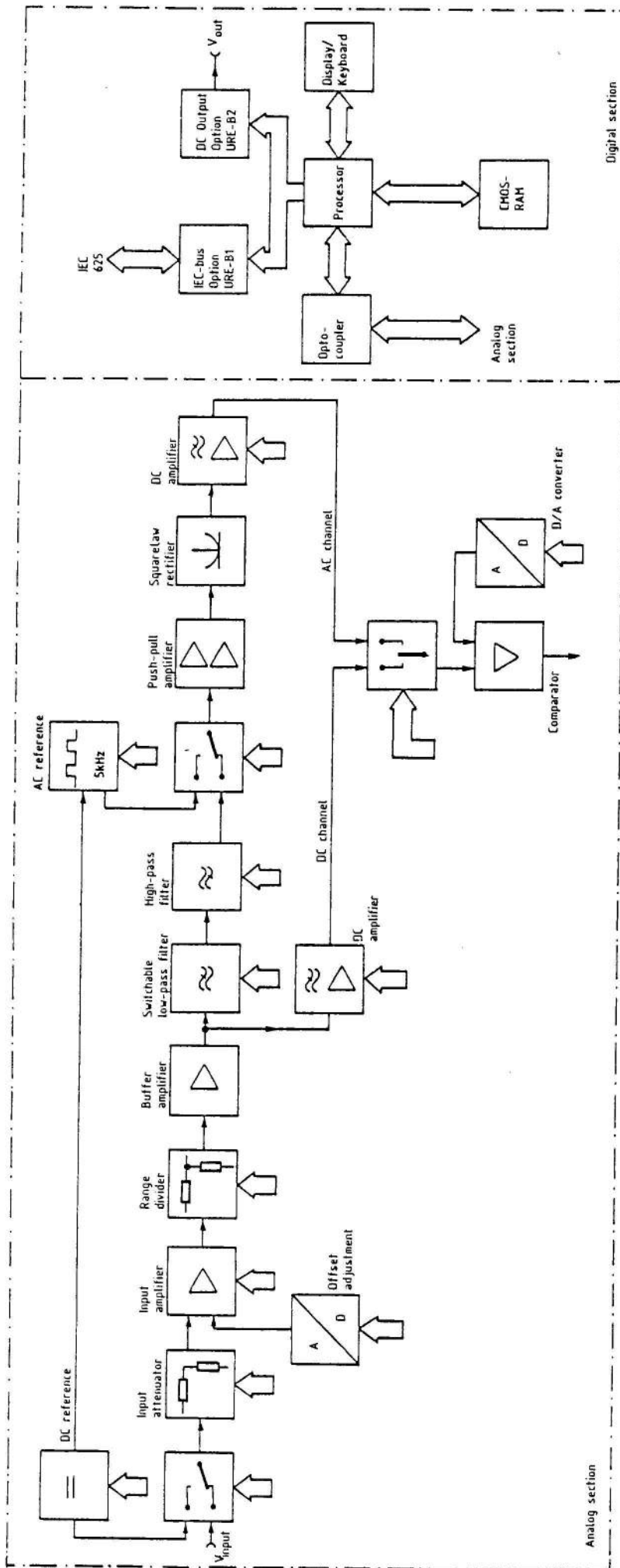

Fig. 4-1 Block diagram of the URE



## 4.2 Computer Board

### Circuit Diagram 342.2010 S

The microprocessor B1 provides the overall control of RMS Voltmeter URE.

To define the start of program execution, about 100 ms after instrument switch-on, the processor receives a signal on its reset terminal from the 5-V voltage monitor T12, B38.

The microprocessor system clock is provided by the squarewave generator with 6-MHz crystal oscillator Q1 integrated in the B1. The derived 3-MHz clock provided on the B1 clock output is used for synchronous control of the peripherals.

Microprocessor 8085 transmits the low-order byte of the address bus and the 8 bits of the data bus in time-multiplexed operation. The low-order address-byte is selected by the ALE signal of the microprocessor via octal latch B24 as address buffer store. The complete 16-bit address bus is formed from the buffer-stored address byte A0-A7 and address byte A8-A15 on terminals 21-28 of the 8085.

The assignment of the 16-bit address blocks to the memories and system peripherals is done by decoding address bits A12, A13 and A14 in decoder B21 (Fig. 4-2).

The execution sequence of the microprocessor system is determined by the program stored in the EPROMs B17-B20, which have a total capacity of 16K bytes.

The main memory of the microprocessor consists of the 1K x 4 bit CMOS-RAM B22 and 256 x 8 bit RAM of peripheral IC B2. When the URE is switched off, the lithium buffer battery BA1 supplies the power needed by the CMOS-RAM. The stored reference and calibration values of the URE are thus preserved.

The program and main memory are accessed via the 8-bit data bus of the microprocessor under control of the  $\overline{RD}$  and  $\overline{WR}$  lines. The direction of data transfer is controlled by line  $\overline{RD}$  to data-bus driver B25.

The input and output of control information occurs via the input/output ports of peripheral IC B2. The state of line A15 routed to terminal IO/M determines whether the input/output ports or the RAM area of IC B2 is addressed.

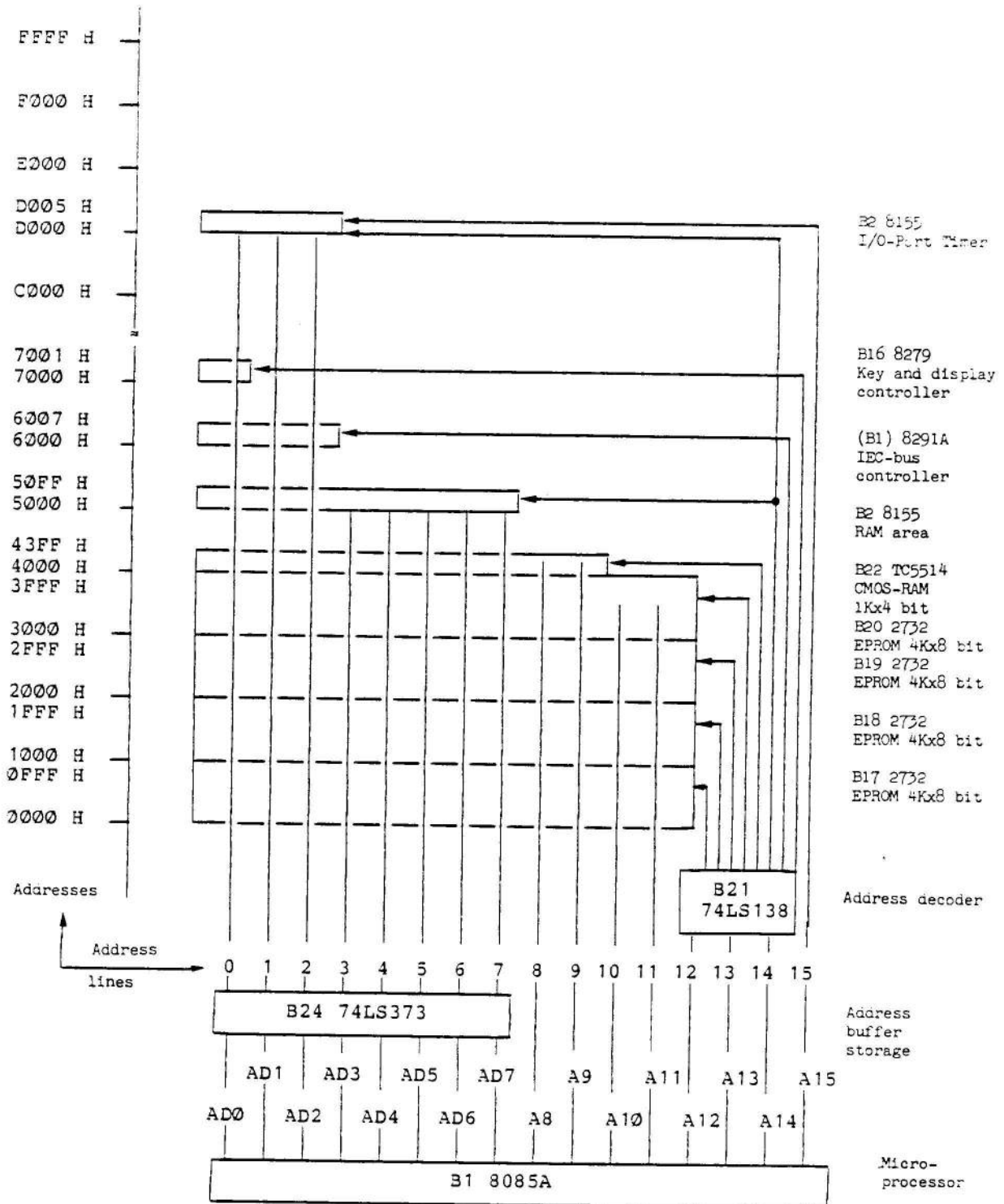

Fig. 4-2 Assignment of Microprocessor Addresses

PA0-PA7 are programmed as output ports and serve for the transmission of all setting data to the analog section via drivers B13 and B14 and optocouplers B4-B12. PB0-PB6 are also output ports and are used for outputting a voltage value at the analog output (Option URE-B2).

PB7 can be interrogated as an input port. It serves for the recognition of the plug-in status of socket BU33. For measurements, BU33 is plugged to ST33. For service operation the shorting bridge BU33 must be removed. The microprocessor notes the service status via PB7 and enables the call of special service functions.

If the IEC-bus option is present, the microprocessor reads in the IEC-bus address set on the address switch via B2 ports PC0-PC4 after the instrument is switched on. This also occurs after a call of service function 1 for a display of the IEC-bus address. At the same time, the NORMAL/TALK-ONLY switch setting is detected via port PC5.

For the function setting of the analog section, the processor delivers binary coded data to the 8-bit port A of IC B2. These signals are transmitted to the analog section via the optocoupler interface, decoded after application of an enabling pulse, and transferred to the buffer stores for the function setting. The enabling pulse is provided by the microprocessor to the analog section via the serial output port SOD and optocoupler B4.

During the microprocessor-controlled analog-to-digital conversion, the microprocessor reads in the status of the comparator from the analog section via the serial input port SID and optocoupler B3. Dependent on this information, the position information for the 16-bit D/A converter is output via port A of B2.

Peripheral IC B16 notes by means of its selection logic when a key has been pressed and causes the microprocessor via interrupt line RST5.5 to read in the code of the selected key via the data bus. Unit B16 also provides the complete output control in time-multiplex operation for the LED display elements.

The B16 clock output signal RS0 from pin 32 also controls the TIMER input T1 of IC B2. The TIMER is programmed so that output  $\overline{T0}$  has a frequency 1/7-th that of the T1 signal. The 119.579-Hz pulse signal controls interrupt input RST7.5 of the microprocessor. For the SLOW setting of URE measurement speed, the microprocessor is caused to request measured values from the analog section synchronous with the timing of the control signal at RST7.5. This serves for exact acquisition of measured values for digital filtering.

#### 4.2.1 Power Supply

In addition to the complete microprocessor system, the computer board contains the rectifying circuits and voltage regulator for the supply voltages to the computer, display/operation and analog sections.

The computer requires only the 5-V supply stabilized in B34. When the URE is switched off, the power for the CMOS-RAM B22 is supplied by the lithium battery BA1. In this quiescent condition, the CMOS-RAM draws a minimum current at about 3 V and retains the stored data. When the URE is switched on, the CMOS-RAM is supplied from the 5-V supply via R16, G17 and G11. Switchover from one mode to the other occurs automatically via G12 and G17.

The input voltage of the 5-V regulator B34 is monitored by G114 via R70, G18, R50 and T12.

The monitoring circuit has a response threshold of about 9.5 V at rectifier G114. Below this level the 5-V regulator and hence the microprocessor operate satisfactorily. Below this threshold, transistor T12 is blocked and prevents, via B38I and B32II, erroneous writing into or erasing of data in the CMOS-RAM while the URE is switched off. When the latter is switched on, the monitoring circuit enables the CMOS-RAM for writing and a reset pulse via R38 initiates the start of the microprocessor. The reset pulse is also sent during service operation at the end of a signature analysis, via B32II, C52 and B38III, IV. These circuit features assure the protection of the reference and calibration data stored in the CMOS-RAM.

The power supplies of the analog section, including rectifier G115 and series regulator B35, B36, B37 for stabilizing the 5-V, +15-V and -15-V supplies, are fed from the various windings of the power transformer. The windings are furthermore separated by double screening in the transformer from the mains and the digital section.

#### 4.2.2 IEC-bus Interface (Option URE-B1)

Circuit Diagram 342.2910 S

IC B1 (8291 A) is connected with the microprocessor data bus and permits data interchange with the peripheral devices via the IEC-625 interface on the rear panel of the instrument.

Data transfer in both directions is provided for, under interrupt control, via the write and read registers of IEC-bus IC B1. The standard termination of the eight data lines, five control lines and three handshake lines is

provided by the bidirectional drivers B2 - B5, which are connected via BU5/ST5 and flat cable with the IEC-bus board and the 24-contact IEC-bus socket BU7. The IEC-bus address is set in 5-bit code by means of switch S25 on the rear panel of the instrument. The URE can thus be assigned any primary address from decimal 0 to 30. An additional setting of switch S25 permits the choice between addressed IEC-bus transfer (NORMAL function) and the TALK-ONLY function. In the latter case, a value displayed on the URE can be output to a LISTEN-ONLY device of the bus system without addressing by pressing a key on the URE.

#### 4.2.3 Signature Analysis

A signature analysis is provided in the URE for checking the microprocessor system.

The signature analysis is activated by repositioning the shorting bridge BU19 on ST19.2/3. This causes the processor to cyclically run through its entire address space.

The data transfer from processor to program memory is in this case interrupted by bus driver B25, and driver B26 is activated and generates a NOP instruction with every read cycle of the processor. The start-stop signals for the signature analyzer are derived directly from the address bus via B27 IV.

For the signature analysis of the data bus only stationary memory data may be used, in order to obtain unequivocal indications as to the functioning of the circuit.

During the signature analysis, readout of data from peripherals 8155, 8279 and 8291A is therefore prevented via gate units B32 III, B31 II,  $\overline{RD}$ -connection and from the CMOS-RAM via B32 III, B32 I, B32 II,  $\overline{CE}$ -connection. After completion of the signature analysis, repositioning of shorting bridge BU19 results in a reset pulse to the microprocessor via B32 III, C52, B38 III and B38 IV.

#### 4.2.4 Analog Output (Option URE-B2)

Circuit Diagram 342.2810 S

In every display cycle a corresponding DC voltage is applied to the analog output.

A display value computed by the processor in binary form is divided by 10 and transmitted in two steps of 6 bits each via output port PB0-PB6 of IC 8155. The intermediate storage in unit B14 provides the 12-bit input for D/A converter B15, which thus provides an analog output of 1 mV/least significant bit at analog output BU1/BU2. The voltage output range lies between -2.048 V and +2.047 V. Potentiometers R43 and R45 are used for the exact adjustment of the D/A converter.

The +15-V inputs to the D/A converter are derived from the 5-V regulated supply of the computer section via converter circuit B33, T13, T15, TR1 with 18-kHz frequency, appropriate transformation, rectification and stabilization with B31 and B32.

#### 4.3 Display Board

Circuit Diagram 342.2410 S

The display board contains

- the URE operating keys,
- the 4-1/2-place 7-segment LED digital display for measured-value output,
- the illuminated display of measured-value units, low-pass function and IEC-bus remote status,
- 12 LEDs for the circularly arranged quasi-analog display.

The reading of the keyboard and outputting of the display information is done in time-multiplex operation via the display-keyboard IC 8279 and the microprocessor.

For key recognition, IC 8279 generates clock signals on RS0-RS2 derived from the 3-MHz microprocessor clock. After decoding in B11, the signals are applied to key matrix S1-S18 which is sampled every 4.8 msec with a pulse width of 0.6 msec for each selection line. If a key is pressed, the clock signals go onto one of the return leads R10, R11, R12 which are in turn interrogated by the 8279. After recognition of a pressed key, the 8279 reports the event via the interrupt line to the processor, which can read in the key code as determined by a matrix via the data bus. The 8279

provides for an electronic debounce of the key contacts and so assures an error-free input.

The signals on RS0-RS3 are decoded in the 4-in-16-line decoder B10 for output to the front-panel display elements.

The drive signals for the LED groups such as the 7-segment digital display B1-B5 and illumination fields B6, B7 are supplied via 15 output lines. The key illumination G115 - G122 and G1 25 is fed in each case via two selectable lines, one of which yields an enhanced illumination.

For the activation of a single segment of an LED group, an 8-bit signal is sent from the 8279 to the display board via lines A0-A3 and B0-B3.

To every line is assigned a specific segment of the group. The segment is activated via driver transistors T10 to T17.

By synchronous control of the group- and segment-selection signals, each individual segment of the LED display can be activated.

By periodic activation every 9.6 msec, it is assured that the display elements do not flicker.

#### 4.4 Analog Board

Circuit Diagram 342.2210 S

##### 4.4.1 Switching Functions

The analog board has the function of processing the voltage being measured. It comprises the following circuit functions:

- Input switchover
- Input amplifier
- Range divider
- Buffer amplifier
- Low-pass-filter switching
- High-pass-filter switching
- Push-pull amplifier
- Measurement rectifier with filtering
- DC amplifier
- Comparator and 16-bit D/A converter for microprocessor-controlled A/D conversion
- DC and AC reference-voltage sources for microprocessor-controlled autocalibration of the analog section

- Decoder and intermediate storage for the control signals of the analog section provided by the microprocessor via output ports
- Level converter for activation of analog switching functions.

#### 4.4.1.1 Input Switchover

For AC voltage measurements, capacitor C6 in the input circuit separates the DC component of the incoming signal. In the DC and AC+DC operating modes, this capacitor is shorted out by relay RS1. Depending on its size, the input signal is passed via relay RS2 to the high-resistance 10-M input-voltage divider with the 1-dB step or the divider with the 41-dB/61-dB step.

Trimmers C8, C13 and C15 serve for frequency-characteristic compensation in the low-frequency range and potentiometer R4 for correction in the higher frequency range of the URE.

MOSFETs T31 - T33 switch the three divider outputs to the wideband input amplifier (Table 4-2).

In DC and AC+DC measurements, an offset comparison of the amplifier branch is made periodically. Depending on the measurement range, resistor R118 may thus be switched to the amplifier input through relay RS3 (see section 4.4.2.3). In the 1-dB divider stage, FET diodes in the input network together with R14, C16 and C18 limit the input voltage range to protect the analog switch and input amplifier.

#### 4.4.1.2 Input Amplifier

This amplifier, with high-impedance FET input stage T6, is designed as an operational amplifier with differential stages. Dual-transistor T5 serves as active load for the FET input stage.

To match the measurement sensitivity of the URE, the input amplifier is switchable to 6-dB and 26-dB gain via analog switch B40 (Table 4-2).

The gain values are determined by feedback resistors R80 - R82 and are adjusted at the upper band limit with trimmers C21, C24.

With use of the 8-bit D/A converter B2 II, B3 and R45 - R58, the offset voltage can be automatically adjusted under microprocessor control. The microprocessor thus changes the input data to the D/A converter in binary steps until the offset voltage of the entire DC measurement section does not exceed the limit set by the 8-bit resolution.



#### 4.4.1.3 Range Divider

The low-resistance range divider with attenuation levels 0/10/20/30 dB provides additional matching to the large dynamic range of the input voltage. From the various combinations of the input divider and input amplifier, a division of the URE input voltage range into twelve 10-dB subranges is brought about (Fig. 4-4, Table 4-2).

#### 4.4.1.4 Buffer Amplifier

The buffer amplifier, consisting of IC B9 and transistors T18, T19, T21, T22 and T30 amplifies the divider output signal by 4.5 dB. The amplifier gain is determined by feedback resistors R136 and R135. Elements C88, C125 and R87 correct the frequency characteristic at the upper band limit.

The buffer amplifier provides decoupling of the following low- and high-pass filters of the attenuators of the range dividers. Following this stage, the signal is separately processed in the AC and DC branches.

#### 4.4.1.5 Low-pass-filter Selection

In the AC measurement circuit a low-pass filter may be switched in by means of FET switches T49 and T55 to limit the bandwidth of measurement. For full bandwidth, the direct signal path via FET switch T50 is cut in.

The low-pass filter with opamp B6 is an active 2nd-order Butterworth filter. A cutoff frequency of 4, 20 or 100 kHz is selected by activation of FET switches T46, T54, T58 and T57 (Table 4-2).

#### 4.4.1.6 High-pass-filter Selection

Three high-pass filters may be switched into the signal path to adapt the AC circuit to the measurement speed. These consist of the capacitors C44 (for  $f \geq 1000$  Hz, SUPERFAST speed), C46 (for  $f \geq 100$  Hz, FAST speed) and C45 (for  $f \geq 10$  Hz, SLOW speed) in conjunction with resistors R280 and R281. The filter selection is made with B36 I, III, IV (Table 4-2).

#### 4.4.1.7 Push-pull Amplifier

After frequency-band limiting by the low- and high-pass filters, it is necessary to amplify and balance the signal before it goes to the measurement rectifier. This is done in the push-pull amplifier, which has a gain of 20 dB. To shorten the transient period in the rectifier, the amplifier

is DC coupled to the rectifier. This in turn requires small offset and drift values of the amplifier for satisfactory transmission of the signal to the rectifier.

The push-pull amplifier comprising ICs B17 and B18 and transistors T23 - T26 delivers amplified signals of opposed phase at the output stages. The in-phase signal, amplifier 14 dB, lies at the output B18II, T25, stabilized by direct negative feedback coupling via R164 and R183 to the B17 input stage. A sum signal derived from both outputs is produced by means of R184, R190, R191 and represents a measure of the output asymmetry. It acts on the collector circuit of the input stage by means of a correction current fed in through stage B17I and determines the symmetry of the output (Fig. 4-3). Pot R174 serves for the zero adjustment of the offset voltage.

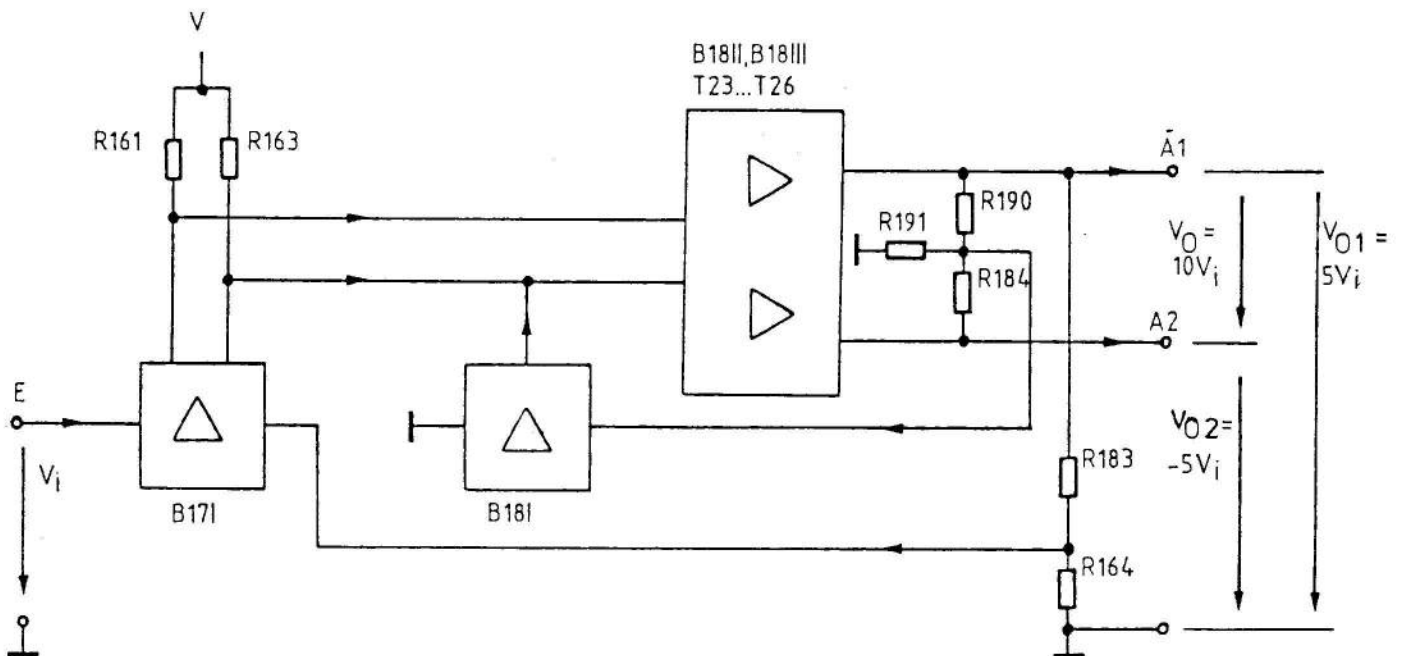

Input stage, symmetry stage, amplifier and output stages

Fig. 4-3 Functional diagram of push-pull amplifier

#### 4.4.1.8 Measurement Rectifier with Filter Circuits

The passive bridge circuit made up of dual FET T27 I, II has the function of forming the RMS value of the AC component of the voltage being measured. The input to the bridge consists of the two phase-opposed outputs of the push-pull amplifier. The bridge circuit performs the squaring of the input signal, the rectified voltage output being given by the simplified formula

$$\left| V_r \right| = \frac{V^2}{8 V_p}$$

where

- V      RMS value of the bridge input voltage
- $V_p$     Pinch-off voltage of the N-channel junction-gate FET,  
value 1 to 1.5 V

Pot R195 is used for compensating small symmetry errors of the two phase-opposed inputs and the rectifier bridge. The symmetrically connected low-pass filter R199, R200, C65 - C67 suppresses the higher frequency components of the rectified signal.

The circuit consisting of the differential amplifier B20 - B22 and the operational amplifiers B23 I, II provides amplification and the filtering low frequency components of the rectified signal. The amplification of the differential amplifier can be adjusted with R201 and R202 in four coarse steps. The large spread in the rectification factor of the FET rectifier is thus taken into account in the adjustment of URE.

The amplifier circuit functions as an active, switchable, low-pass filter. In FAST and SUPERFAST measurements it forms a 3rd-order filter with a pole in amplifier B20, B21 and two poles in the active low-pass filter formed with B23I.

In SLOW measurements, the circuit with switch-in of capacitor C76 forms essentially a 1st-order filter. Together with a software based recursive-digital filter of 3rd order, a 4th-order filter results with particularly good transfer characteristics.

The advantages are the optimal setting behaviour and the suppression of the low-frequency components down to the measurement frequency of 10 Hz (dielectric error effects of large filter capacitors are avoided).

Through the input of the 10-V DC voltage via amplifier B22 a level shift of -8.4 V results at rectifier output ST2.2. This provides for optimal utilization of the bipolar voltage range of the 16-bit D/A converter B25 (see 4.4.1.10).

The rectifier DC output voltage goes via FET switch T51 to comparator B24 and after microprocessor-controlled A/D conversion (successive approximation) is further processed in the computer section of the URE (see section 4.4.2).

#### 4.4.1.9 DC Amplifier

After passing through the buffer amplifier, the DC component of the measured signal is further processed in the DC measurement circuit, consisting of amplifier B10 in conjunction with active low-pass filter stages. The amplification factor of 76 is determined by the feedback coupling R125, R133.

The active filters serve for the suppression of the AC components of the measured signal. The cutoff frequencies are set by MOSFETs T41 - T44 in accordance with the selected measurement speed (Table 4-2). Filters of different orders result as follows:

- For the SUPERFAST setting,  
a 4th-order filter with three poles via B10 and RC network R278, C134.
- For the FAST setting,  
an active filter of 3rd order via B10.
- For the SLOW setting,  
a 1st-order filter via C111, T44 and B10 which in combination with a digital filter in software realization functions as a 4th-order filter.

The output voltage of the DC measurement circuit passes through FET switch T52 to comparator B24 for microprocessor-controlled A/D conversion.

The circuit formed by G125 and G134 functions when FET T53 is switched in, as limiter of negative output voltages falling below -8 V. This prevents possible overdriving of the DC amplifier influencing the evaluation of the AC channel.

#### 4.4.1.10 Microprocessor-controlled A/D Conversion

After preprocessing, the voltage being measured is converted to digital form by means of successive approximation carried out in the analog section by comparator B24 and 16-bit D/A converter B25 with input circuits B26, B27, B28, B30 and B31.

The microprocessor is connected via the optocoupler interface. The processor applies data stepwise to the D/A converter, beginning with the most significant bit. The comparator compares the resultant output of the converter with

the output voltage of the AC or DC measurement circuit. After every such step, the processor reads the logical state of the comparator output via an optocoupler into the serial input port SID. It is then tested whether the set input bit of the D/A converter is correct or not. This process is continued to the least significant bit (16th bit). Every correctly set bit is summed by the processor corresponding to the binary value.

After completion of the conversion, the measured voltage in digital form with value 0 to 65535 is stored for further use by the microprocessor.

Before each conversion, the microprocessor sends a pulse, via reset line BU3.15, latch units B30 and 31 and inverting drivers B26 - B28 to reset the D/A converter to the start state, i.e. with all bits set to logic 1. This setting corresponds to a D/A converter output of -10 V. The measurement range extends from -10 V to +9.99969 V.

D/A converter B25 also provides the stabilized 6.3-V DC reference voltage for use in deriving further DC and AC reference voltages for the analog section.

#### 4.4.1.11 DC and AC Reference Voltages

Highly stable DC and AC voltage generators are required for the microprocessor-controlled autocalibration of the analog section.

The DC reference generator processes the 6.3-V reference from the D/A converter to provide, via circuit B2I, T3, a 10-V DC reference, from which resistor network R23 derives the 1-V and 0.1-V DC reference voltages.

The DC reference voltages are adjusted to their rated values with R33, R36 and R39.

With the 4-part analog switch B1, the three DC reference values and zero-voltage reference are applied to the input circuit of the URE. An additional reference voltage of 0.71 V is derived over the resistive voltage divider R17, R27 which can be cut in with T34.

The 0.71-V and 1-V DC references are chopped to produce, via analog switch B14 and timing generator B13, two highly stable AC reference voltages for calibration of the AC measurement circuit. The timing frequency is 5 kHz.

Voltage follower B16 serves to provide a low-impedance input to voltage divider R169, R168, R166, R171. The AC references can be switched with FET switch T56 to the input of the push-pull amplifier. After removal of the DC

component by C49, the effective (rms) value of the generated AC references are 21 mV and 30 mV respectively.

The output voltage of the AC reference branch may be set by R171 for rated-value adjustment of the AC indication. By switching off timing generator B13, a zero-voltage reference may be generated via the AC reference branch at the input of the push-pull amplifier for use in calibrating the measurement rectifier.

#### 4.4.1.12 Transmission and Decoding of the Analog Control Signals

The microprocessor sends coded control signals to the analog board via the output ports and optocoupler. For assigning place values, the appropriate coded information is transmitted via interface BU3.

The signal bits are applied in parallel to lines BU3.1, 2, 3, 4, 5, 12, 16. The three bits on lines BU3.4/.5/.12 are decoded to select one of the buffers B3, B4, B5, B12, B15, B30 or B31. The three bits of lines BU3.1, 2, 3 serve for addressing the outputs of the 8 buffers. Line BU3.16 carries the bit identifying the logical state of an addressed analog function.

For the acceptance of the applied coded data by the buffers, the microprocessor outputs a short pulse via serial output port SOD onto line BU3.14. After inversion in unit B62VI, the pulse is applied to decoder B29 to enable decoding of the applied input data. For the duration of the acceptance pulse, decoder B29 outputs on terminals Q0-06 the signal for selecting one of the addressable buffers. The latter decodes the address information on inputs A0-A2 when input line WD goes to 0.

The addressed unit then delivers at the output specified by A0-A2 the logical state (0 V or 5 V) determined by the data bit on the D input.

The transmitted and decoded information remains stored until a new state is selected or the instrument is switched off. 55 individually programmable outputs for controlling the analog functions are thus obtained.

At program start a reset pulse is sent via output Q7 of decoder B29 to reset addressable stores B3, B4, B5, B12 and B15.

#### 4.4.1.13 Activation of Analog Switching Functions

The activation of all analog functions proceeds from the stored output states i.e. 0 V or 5 V of the addressable 8-bit latch. The analog switch requires special control levels which are generated with comparators B51, B52, B53, B54, B56, B57, B59 and B60 (Table 4-1). The comparators are driven by the 0 V or 5 V logic signals of the 8-bit latch.

One of the two inputs of each comparator is for this purpose connected with a common line at +2.5 V being derived via R5 and R6 from the 5-V supply.

Table 4-1

Control level for the analog switch

Level	Analog switch
0 V/+15 V	B1, B13, B14
±15 V	B40, T31 - T58
-7.5 V/+15 V	B36I, III, IV

#### 4.4.2 Function Sequence

In both manual and IEC-bus-controlled operation, the URE performs measurements under microprocessor control. The program includes the following routines:

- The setting routines to place the analog section in the desired measurement mode.
- The A/D conversion routines for digitalizing the analog representation of the measured voltage.
- Routines for automatic measurement-range selection in AC, DC and AC+DC measurement.
- Routines for manual selection of the range when autoranging is switched off (Range hold).
- Routines for periodic offset correction of the amplifier in DC and AC+DC measurements.
- Routines for periodic calibration of the rectifier in AC and AC+DC measurements.
- Callable autocalibration routine for the determination of all measurement-range factors and the rectifier-characteristic coefficients.

- Routine for digital filtering in SLOW measurements.
- Routines for computing the display value from the measurement, calibration and offset values for computing the RMS value of a mixed voltage from the AC and DC components, and for converting to relative display values in units of dBm, dBV,  $\Delta$ dB,  $\Delta$ V,  $\Delta$ % and V/REF.

#### 4.4.2.1 Autocalibration

See also sections 3.3.1 and 5.2.1.2

The URE has a callable routine for calibrating the analog section.

The autocalibration routine selects certain measurement ranges for calibration and provides the zero-reference and DC-reference voltages, which are switched into the input circuit via RS2.

The A/D-converter routine measures the zero and reference output voltages several times in each measurement range. After averaging and forming the difference between reference and zero measurements, the calibration values for ranges 4, 5, 6, 7, 8, 9 and the two auxiliary ranges 13 and 14 are obtained (see sections 5.2.1.2 and Table 4-2). All other measurement-range factors are converted from these values.

This procedure allows calibration of the measurement ranges and the A/D conversion with the accuracy and stability of the three DC reference voltages.

The results of the measurement-range calibration are stored in the CMOS-RAM in the form of A/D-converter step numbers which are then taken into account in the computations associated with a voltage measurement.

The routine also performs a calibration of the RMS rectifier with use of two AC reference voltages and zero reference. For this the voltages are switched in turn to the input of the push-pull amplifier and the output of the square-law rectifier measured by way of the A/D conversion.

The AC reference voltages are derived from the 0.71-V and 1-V DC references (see section 4.4.1.11).

For the autocalibration of the rectifier characteristic, the ratio of the AC voltages must first be exactly determined. Since the amplitudes of the AC voltages are proportional to the DC reference voltages, it is sufficient to determine the ratio of the latter.



For this, as in the range calibration, the 0.71-V DC, 1-V DC and zero references are switched to the URE input circuit and the output voltages of the DC measurement circuit measured using measurement range 6. The ratio is computed by the microprocessor.

The results of the three rectifier calibrations permit the computation of the three characteristic coefficients of the square-law measurement rectifier. The coefficient values are stored in the CMOS-RAM. They are used in a voltage measurement to compute the RMS value of the AC voltage from the output of the square-law rectifier (section 4.4.2.2).

During the calibration, the nominal/actual values are compared with rated values and tolerances provided in the program. If a calibration value exceeds the tolerances, an error message Err 1...15 is displayed on the URE or in remote operation a status byte is sent to the IEC-bus controller (section 5).

A complete autocalibration cycle requires about 20 seconds. The URE then reverts automatically to the measurement mode.

#### 4.4.2.2 RMS-value Measurement and Rectifier Calibration

See also section 4.4.1.8

In response to an input of a pair of phase-opposed sinusoid signals within certain tolerances, the FET rectifier bridge T27 I, II produces an output whose mean value is given by the formula

$$V_o = V_{oo} + bV^2 + (3/2) cV^4$$

where V is the RMS value of the input voltage.

For the computation of the RMS value, the three parameters  $V_{oo}$ , b and c of the characteristic must be known. The values of these parameters are determined in the autocalibration by appropriate reference measurements and conversions (section 4.4.2.1).

The coefficient c represents a deviation from a pure square-law characteristic and has a relatively low value. For any particular FET this coefficient is constant and will therefore be only determined once - during the autocalibration.

The coefficients  $V_{oo}$  and b on the other hand are time and temperature dependent to some degree and are therefore periodically determined with appropriate reference measurements.

The periodic calibration of the rectifier is made at regular intervals, the length of the interval depending on the measurement speed to which the URE is set:

For measurement speed SUPERFAST, every 9 sec (approx.)  
FAST, every 11.5 sec (approx.)  
SLOW, every 16.5 sec (approx.)

The voltage measurements are interrupted about 170 ms for each calibration.

For the periodic determination of coefficients  $V_{oo}$  and  $b$ , the AC reference branch is switched to the input of the push-pull amplifier. The voltage under test is thereby disconnected. To prevent cross-talk of higher-frequency components into the reference branch, the inputs to the buffer amplifier and coupling capacitors C44-C46 are also disconnected.

After the zero reference has been produced in the AC reference branch, the first comparison measurement yields the offset voltage for the output of the AC measurement circuit and thus the value of the coefficient  $V_{oo}$ .

The second measurement is made with the larger of the two AC reference voltages derived from the 1-V DC reference by chopping. The squarewave voltage, after voltage division and elimination of the DC voltage, is applied to the push-pull amplifier. The size of the AC reference corresponds to the upper limit value of the measurement range involved. The rectified signal provides the value for determining the value of coefficient  $b$ .

During the rectifier calibration, the active filters are switched to SUPERFAST operation in order to perform the calibration as speedily as possible.

The coefficient values are stored and used in subsequent measurements of RMS values.

Pot R171 provides for the setting of a correction factor to adjust to the rated value of the display for a specified AC input voltage.

#### 4.4.2.3 DC Voltage Measurements and Offset Correction

In DC and AC+DC operation, after every change of the measurement range as well as periodically, the DC measurement circuit is tested and an offset correction made of the entire amplifier branch including the A/D converter. For this purpose, the test voltage input is disconnected from the input amplifier and a zero voltage produced. Incorrect voltage at the output of the DC measurement circuit is detected at the A/D converter output. The value is stored and used to correct all measured DC values.

Additionally, in DC voltage measurements the URE switches momentarily during

every measurement cycle to the AC measurement circuit and monitors the input. When maximum input voltage is exceeded a less sensitive DC range is selected until maximum input is again observed in the AC measurement circuit.

Settings of the analog section for offset measurements:

Analog switch

In ranges with 1-dB input dividers:	Relay RS2 switched off; zero-voltage reference provided via analog switch B1 III.
In ranges with 41-dB or 61-dB input dividers:	Resistor R118 switched to amplifier input with RS3; FET switches T31 and T32 switched off.
General:	Filter in DC measurement circuit set to SUPERFAST by switching off FET switches T41 - T44.

The offset correction is made periodically at the same time intervals as the rectifier calibration (section 4.4.2.2). The DC voltage measurement is interrupted for about 100 ms for this procedure.

During every offset measurement, it is checked whether the offset voltage lies within the permitted range of  $\pm 1.3$  V at the output. If it lies outside this range, offset adjustment of the input amplifier is performed automatically. With the URE set to the 1-mV range, a correction voltage is applied to the input amplifier with the use of the 8-bit D/A converter until the offset voltage at the output of the DC measurement circuit falls within the range corresponding to the 8-bit resolution. This offset adjustment requiring about 340 ms prevents run-away of the offset voltage by, for example, large temperature changes. The adjustment setting of the D/A converter remains stored.

If for any reason the offset voltage cannot be reduced to a permitted value, a functional fault is present. The URE then displays the error message Err 1 (section 5).

The value of the DC voltage being measured is made up of the value measured by the DC measurement circuit, the offset voltage and the calibration values for the measurement range involved.

#### 4.4.2.4 Mixed (AC+DC) Voltage Measurements

In the AC+DC measurement mode, the AC and DC measurement circuits are alternately switched to the comparator for A/D conversion.

The AC and DC components of a mixed signal are determined in the AC and DC measurement circuits respectively in the same way as for a pure AC or DC signal.

With correct choice of the measurement range (section 4.4.2.5), the RMS value of the mixed voltage is computed by the microprocessor routine with the equation

$$V = \sqrt{V_{AC}^2 + V_{DC}^2}$$

In the case of AC+DC measurements, the periodic calibration includes the DC offset correction and rectifier calibration in a single program routine. The combined calibration requires about 240 ms.

#### 4.4.2.5 Automatic Range Selection and RANGE HOLD

Automatic range selection or autoranging is microprocessor-controlled according to the rules given below. It makes possible a rapid, optimal selection of the measurement range.

##### a) Measurement range exceeded by input

- If during the A/D conversion the maximum step number of 65535 ( $= 2^{16}-1$ ) is reached, subsequent action depends on what measurement range the analog section is set to.
- If in the range switched in, the 1-dB input divider is used, the highest range using the 1-dB divider is switched in (AC: 300-mV range, DC: 1-V range). If the new range is still too low, the highest range (300 V) is then switched in.
- If the 41-dB or 61-dB divider is used in the range involved, the highest range (300 V) is immediately switched in.
- If the range is found to be too low without the step number of the converter being exceeded, the next higher range is switched in. This increases the range by  
10 dB in the AC mode and  
20 dB in the DC mode.

The switching thresholds are:

DC: display voltage value  $\geq$  12000 digit steps

AC: display voltage value  $\geq$  12000 or  $\geq$  3600 digit steps,  
depending on measurement range.

##### b) Measurement range too high for input.

If the optimal range for the display value lies below the range cut in, a more sensitive range is automatically cut in:

for DC measurements: display voltage value  $\leq 1003$  digit steps,  
for AC measurements: display voltage value  $\leq 3003$  or  $< 1003$  digit steps,  
depending on the range.

If the input voltage is more than 30 dB for AC and more than 40 dB for DC below the nominal lower limit of the range cut in, a new range is selected that is 30 dB and 40 dB more sensitive, respectively. In all other cases, the next more sensitive range is cut in.

In AC+DC operation, automatic range selection selects a range that is optimal for either the AC or DC component. The range can then be higher than optimal for the other component. This however is not too important from the standpoint of measurement accuracy, since the optimally measured component is the dominant one.

During a change of range in automatic range selection, the display remains generally dark and a new value is not displayed until the URE has found the correct range. This does not apply however when the instrument for some reason cannot find a suitable range. In this case, after a certain number of attempts, a blinking value is displayed and the automatic routine resumes its search.

In RANGE HOLD operation, if the range is exceeded by the input, higher ranges are switched in (i.e. the range is not held) and the entire display blinks. If the range is too high for the input, it remains unchanged, but the last digit of the display blinks in this case to indicate that the measurement is not being made with the optimal range.

Function		Analog switch settings	
AC range	DC range		
1 (1 mV)		B40III IN,	T45+T47 IN
2 (3 mV)	3 (10 mV)	B40III IN,	T48 IN
3 (10 mV)			T45+T47 IN
4 (30 mV)	5 (100 mV)	Rs2 IN	T48 IN
5 (100 mV)			T35 IN
6 (300 mV)	7 (1 V)	B40I,II,IV IN	T36 IN
7 (1 V)			T45+T47 IN
8 (3 V)	9 (10 V)		T48 IN
9 (10 V)			T35 IN
10 (30 V)	11 (100 V)	Rs2 OUT	T36 IN
11 (100 V)			T35 IN
12 (300 V)	12 (300 V)		T36 IN
13 (Auxiliary range for autocalibration)		Rs2 IN, T32 IN, B40III IN, T48 IN, B1IV IN	
14	"	"	Rs2 IN, F31 IN, B40III IN, T48 IN, B1I IN
Operating mode AC		Rs1 IN, T51+T53 IN, T52 OUT	
Operating mode DC		Rs1 OUT, T52 IN, T51+T53 OUT	
Measurement speed			
SUPERFAST		B36III IN	
FAST		B36I+T37+T38+T40 IN T41...T43 IN	
SLOW		B36IV IN, T37...T40 IN T44 IN, T41...T43 OUT	
Low-pass filter IN		T49 IN, T55 IN	
Low-pass filter OUT		T50 IN	
LP Select	4 kHz	T46+T54+T57+T58 IN	
LP Select	20 kHz	T54+T57 IN	
LP Select	100 kHz	T46+T54+T57+T58 IN	
DC reference voltages			
	10 V	B1I IN	
	1 V	B1IV IN	
	0.71 V	T34 IN	
	0.1 V	B1II IN	
	0 V	B1III IN	
AC reference voltages			
	30 mV	T56 IN, Generator B13 IN, B14I IN	
	21 mV	T56 IN, Generator B13 IN, B14II IN	
	0 V	T56 IN, Generator B13 OUT, B14 IV IN	
Offset measurements in measurement ranges with 41-dB or 61-dB input divider		Rs3 IN, T31...T33 OUT	

Table 4-2 Analog Switching Functions

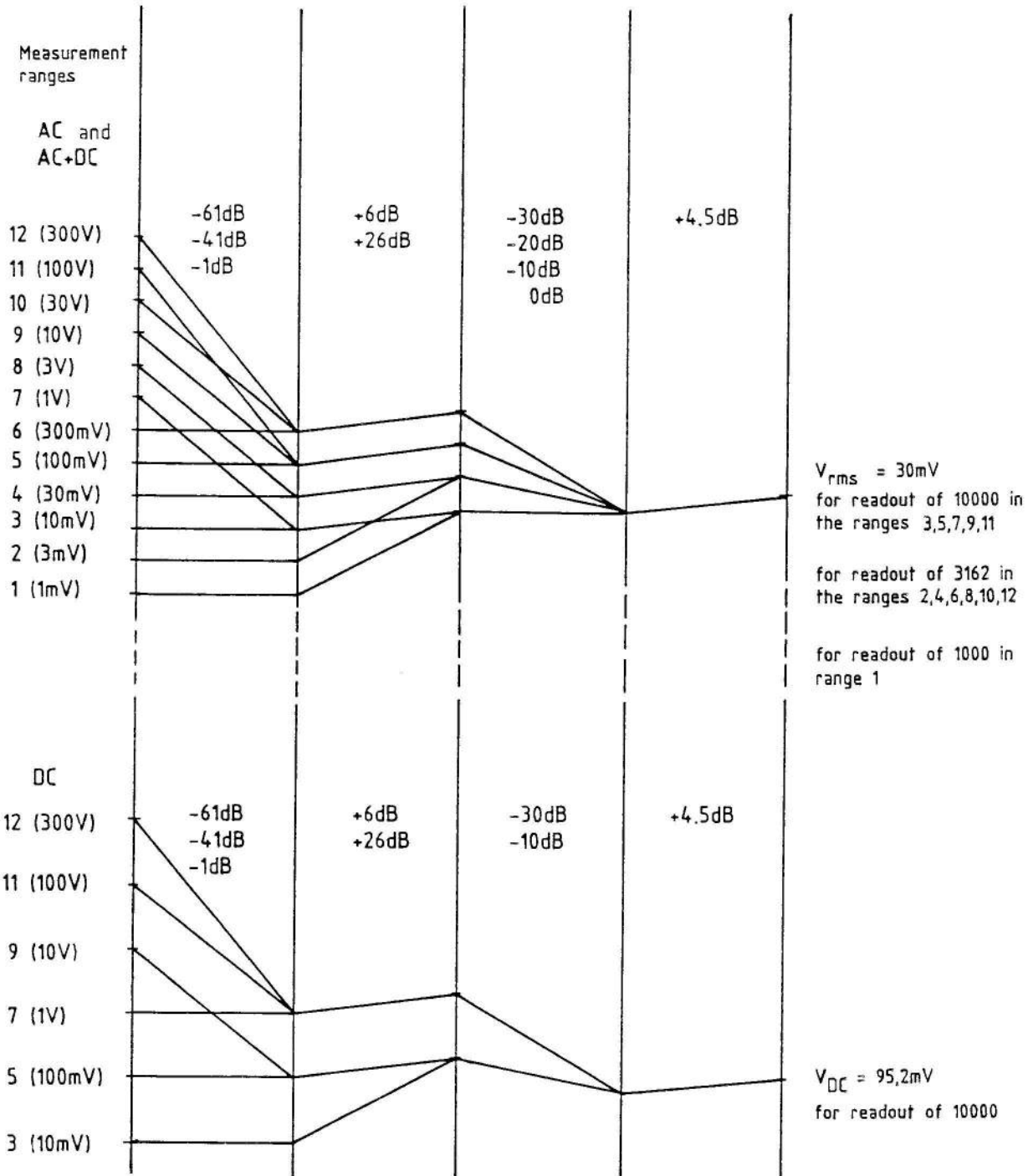
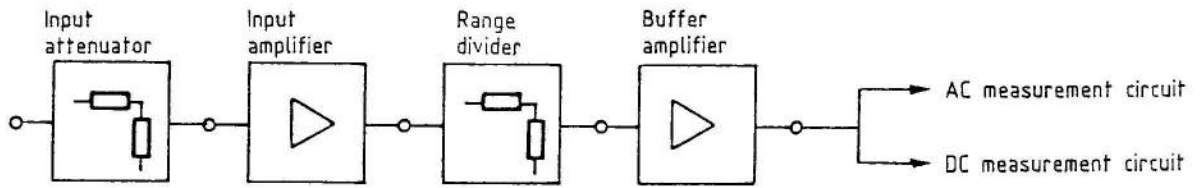

Fig. 4-4 Level chart for measurement subranges

## 5. Repair

### 5.1 Equipment Required

See Table 3-16 at end of section.

### 5.2 Troubleshooting

The following drawings and documentation should be used for fault finding:

- Circuit diagrams,
- Printed wiring diagrams with component layout,
- Functional description, section 4.

The most important troubleshooting procedures are the check of the test points, power-supply and control-voltage checks with a digital voltmeter or oscilloscope, signal tracing in the analog subassemblies with a RF millivoltmeter and signature analysis of the functional groups of the computer section.

For such work, the top and bottom covers of the URE are removed, after loosening the four Phillips-head retaining screws.

Very useful aids in troubleshooting, testing and adjusting the analog functions are the service functions 5 to 9 (section 2.3.3.7.2, Table 2-1, section 5.2.1.1) and the error messages (section 5.2.1.2).

Suggestions for localizing errors in case of certain fault symptoms are given in section 5.2.1.3.

#### 5.2.1 Servicing Aids

##### 5.2.1.1 Service Functions 5 to 9

Service functions 5 to 9 (see section 2.3.3.7.2 and Table 2-1) are used for setting the URE for troubleshooting and adjustment of the analog functions.

Shorting bridge BU33 on the computer board is removed for the activation of these service functions. After one of these functions is called, the URE performs a setting routine and remains in the resultant state. The instrument is returned to the prior measurement mode by pressing the SHIFT key again.

With service function 5 - Absolute value adjustment,  
the instrument is set to operating mode AC, measurement range 5 (100 mV), measurement speed FAST, LOW PASS out.



The routine performs a continual comparison of the reference AC voltage (duration 100 ms) with the applied rated value of the input AC voltage (duration 300 ms) and permits the exact adjustment to the rated value of the indication (section 5.3.1.4).

With service function 6 - Rectifier adjustment

the instrument is set to operating mode AC, measurement range 5 (100 mV), measurement speed FAST, LOW PASS out, stationary. No periodic comparison with the AC reference voltage is made in this case. The setting is used for trouble shooting and adjusting the RMS-value rectifier.

The message S E r 6 is displayed. (sections 5.2.7.1, 5.2.7.4, 5.3.1.2)

With service function 7 - Analog output offset adjustment

the voltage -2.048 V is output independently of the measurement setting at the analog output (Option URE-B2). This setting is used for checking the analog output and adjusting it to the rated value.

The message S E r 7 is displayed. (sections 5.2.5, 5.3.2)

With service function 8 - Analog output amplifier adjustment

the voltage +2.047 is output independently of the measurement setting at the analog output (Option URE-B2). This setting is used for checking the analog output and adjusting it to the rated value.

The message S E r 8 is displayed. (sections 5.2.5, 5.3.2)

With service function 9 - Reference voltage adjustment

the DC reference voltages are switched to the input circuit of the URE. After service function 9 is called, the code number 0, 1 or 2 is entered to select

the following inputs:

	<u>Code number</u>	<u>DC reference voltage</u>	<u>Indication</u>
	0	100 mV	9 100 mV
	1	1 V	9 1 V
	2	10 V	9 10 V

At the same time the AC reference generator is cut in with service function 9, code number 2.

The settings serve for checking and adjusting the reference voltages (sections 5.2.7.7 and 5.3.1.1).

Note: When the settings are made via IEC (IEEE) bus the service function 9 is replaced by the three service instructions S1, S2, S3 (see Table 2-9).

### 5.2.1.2 Error Messages and Evaluation

The URE software produces the following error-message displays (section 2.3.3.9).

Table 5-1 Error Messages

Code	Cause
0	Reference input incorrect, no functional error
1	DC offset error
2	Rectifier offset error
3	Error 1 + 2
4	Rectifier-amplifier error
5	Error 1 + 4
6	Error 2 + 4
7	Error 1 + 2 + 4
8	Calibration value incorrect
9	Error 1 + 8
A	Error 2 + 8
b	Error 1 + 2 + 8
c	Error 4 + 8
d	Error 1 + 4 + 8
E	Error 2 + 4 + 8
F	Error 1 + 2 + 4 + 8

If the IEC-bus option is installed, the interrogation of error messages via the service functions (Table 2-9) is possible by means of the controller.

If instruction Q1 (Service Request) has been sent, the appearance of an error message 1-F results in the controller outputting the status byte as decimal equivalent 100.

The controller can request the error code with the control signal SP. On the controller and on the URE display the error code is output as decimal value from 0 to 15. No functional error is indicated if error code 0 is output.

A further decoding of the error message E R r 8 (to F or 15) is possible by displaying the calibration values on the URE display with use of the IEC (IEEE)-bus control instructions SA to S0 as shown in Table 5-2.

Table 5-2 Evaluation of Error Messages 8 to F or 8 to 15

Control instruction	Function		
	Readout of calibration value AC or AC+DC range	Rated value	Permitted deviation (+/-)
SA	1	1511	45
SB	2	4768	142
SC	3	1502	45
SD	4	4740	142
SE	5	1496	45
SF	6	4738	142
SG	7	1502	45
SH	8	4740	142
SI	9	1496	45
SJ	10	4739	142
SK	11	1497	45
SL	12	4739	142
SM	13	4769	142
SN	14	4769	142
SO	Read out of rectifier linearity coefficient	2048	70

If the permitted deviation is exceeded, the URE displays the error message  
E r r 8.

Measurement ranges 13 and 14 are used for the determination of the amplification parameters during autocalibration. The calibration values for ranges 4, 5, 6, 7, 8, 9 and 13, 14 are determined by internal measurements with use of the DC reference voltages. The remaining range factors are computed from these values by the microprocessor.

The rated range calibration values multiplied by 5 yields the number of conversion steps of the 16-bit D/A converter as determined by the microprocessor.

These values are a direct measure of the amplification value of the individual range.

The linearity coefficient of the rectifier characterizes the deviation of the FET characteristic from an exact square-law. This deviation is taken into account in every measurement and the necessary correction made.

### 5.2.1.3 Error Symptoms

Error Symptoms	Error location in subassembly	Section
Display fields and key-board remain dark after URE switch-on	Power supply, power input, display/key interface unit, computer (comp. board)	5.2.2 5.2.3
Nonsensical readout, no reaction to key entry	Computer board	5.2.3
Various display fields or digit segments or key illumination do not function	Display board	5.2.6
No reaction to remote instructions and data inputs via IEC-bus	IEC-bus option (computer board)	5.2.4
Analog output wrong	Analog output option (computer board)	5.2.5
Error message E r r 8 after URE switch-on	CMOS-RAM Data security, Buffer battery, (computer board)	5.2.3.1 5.2.3.2
Error message E r r 8 during an autocalibration	Analog control function, DC reference voltage, Amplifier branch, Rectifier, 16-bit D/A converter, (analog board)	5.2.7.1 5.2.7.7 5.2.7.2 5.2.7.3 5.2.7.5 5.2.7.6
Error message E r r 8 via IEC-bus instructions:		
Calibration value wrong	DC reference voltages, Input circuit, Amplifier branch, D/A converter, (analog board)	5.2.7.7 5.2.7.2 5.2.7.3 5.2.7.6
Rectifier linearity coefficient wrong	AC reference generator, DC reference voltages, Push-pull amplifier, Rectifier (analog board)	5.2.7.7 5.3.2.1 5.2.7.4 5.2.7.5
Error message E r r 1	Input amplifier, 8-bit D/A converter for offset correction (analog board)	5.2.7.2 5.2.7.6

Error Symptoms	Error location in subassembly	Section
Error message E r r 2	Push-pull amplifier, Rectifier amplifier, (analog board)	5.2.7.4 5.3.1.2.3
Error message E r r 4	AC reference generator, Push-pull amplifier, Rectifier, (analog board)	5.2.7.7 5.2.7.4 5.2.7.5

The occurrence of combinations of error messages 1, 2, 4, 8 per section 5.2.1.2 permits a further pin pointing of error causes.

### 5.2.2 Troubleshooting and Check of Power Supply

See Circuit Diagram 342.1214 S

- Check of fuse and the AC power-voltage setting (section 2.3.3).
- Check of all cable and plug-and-socket connections of AC power supply and transformer secondary connections.
- Measurement of voltages and comparison with circuit-diagram values.
- If the power supply is overloaded or a fuse has burned out, it is advisable to separate the computer and analog circuits from the power by removing bridges BU15 to BU18 and to continue the search with the power supply unloaded.
- Further checks of power supply given in section 5.2.3.1.

### 5.2.3 Troubleshooting and Check of Computer Board

See Circuit Diagram 342.1214 S

Circuit Diagram of Computer Board 342.2010 S, sheets 1 + 2,  
PC board diagram 342.2010, sheets 2 + 3

The test points and the most important components of the computer board are directly accessible from the top of the instrument (Fig. 5-1).

After removal of four Phillips-head screws, the computer board may be swivelled out for further measurements and possible exchange of components (Fig. 5-2).

The IEC-bus board and analog-output assembly can then also be removed by gently pressing together the plastic clips on the solder side of the computer board.

### 5.2.3.1 Check of Supply Voltages

#### a) Voltage supplies for computer and display boards

- Check of voltages on computer board:

Reference point ST25 ST/BU15	0 V +5 V $\pm 5\%$
GL14 + connection	approx. +11 V

- Check of current consumption after removal of BU15 and insertion of a DC ammeter:

On ST15 pins 1 and 2	typical 1.0 A (without IEC-bus typical 0.7 A)
----------------------	---

With larger deviations from rated value of 5 V:

- Remove BU15 and insert 5  $\Omega$ , 5 W loading resistor between ST15.1 and chassis (ST25).
- Measure output voltage on ST15.1  
to decide between voltage supply and computer and display circuits  
as possible source of error.

#### b) Voltage supply for analog board:

- Check of voltages on the computer board:

Reference point ST26 BU/ST16 BU/ST17 BU/ST18 B36 pin 1 B37 pin 3	0 V + 5 V $\pm 5\%$ +15 V $\pm 0.6$ V -15 V $\pm 0.6$ V approx. +23 V approx. -24 V
---	--

- Check of current consumption after removal of socket BU16, BU17 or BU18 and insertion of a DC ammeter.

On ST16 pin 1 to 2	Typical 30 mA strongly varying
On ST17 pin 1 to 2	Typical 130 mA
On ST18 pin 1 to 2	Typical 100 mA

With larger deviations from rated value:

- Remove sockets at outputs of voltage regulators B35, B36 and B37 and insertion of a loading resistor to analog reference point ST26 (on ST16.1, 33  $\Omega$ , 1 W; on ST17.1 or ST18.1, 120  $\Omega$ , 2 W).
- Measure output voltages to decide between the voltage supply and analog-section circuit as possible source of error.

c) Voltage supplies for CMOS-RAM

- Check of voltages on computer board:

Reference point: pin 2 of battery connector	0 V
ST39 URE switched on	typical 5.2 V $\pm 5\%$
ST39 URE switched off	typical 3.4 V $\geq 3.0$ V
BA 1 connection 1	$\geq 3.2$ V
URE switched off	3.67 V for new battery

- Check of current consumption after unsoldering battery terminal 2 and inserting a DC micro-ammeter:

On BA 1 URE switched off	typical 0.1 $\mu\text{A}^{+)$ maximum 10 $\mu\text{A}^{+)$
On BA 1 URE switched on	typical -0.05 $\mu\text{A}^{+)$

+ ) At 25°C ambient temperature

### 5.2.3.2 Check of Microprocessor and Peripheral Units

a) Check of microprocessor reset and clock pulses:

RESET IN pulse on ST14.4:

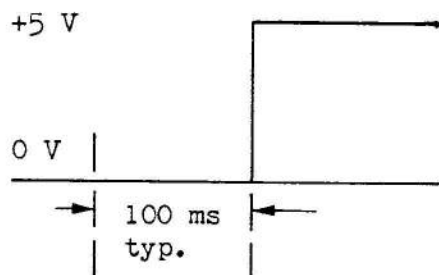

RESET OUT pulse on B1.3:

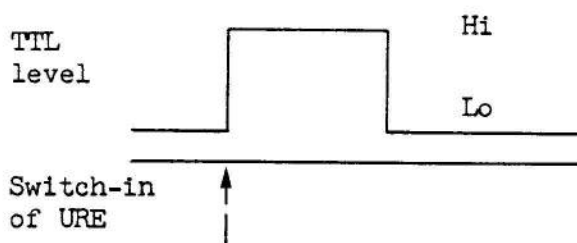

CLOCK pulse on B1.37:

3-MHz square clock signal, TTL level

b) Signature analysis

For testing the microprocessor system, the URE is provided with a hardware based signature analysis.

During a signature analysis, the microprocessor is caused to make a run through its entire address space periodically.

The data transmission from the processor to the program memories (EPROMs) via bus driver B25 is interrupted and driver B26 is activated generating a NOP instruction in every read cycle of the processor.

The Start/Stop signals for the signal analyzer are derived directly from the address bus.

The signatures provide a check on the processor and driver and address-decoder units as well as the EPROMs.



Settings and Checks:



- To activate the signature analysis reposition BU19 on ST19.2/3.
- Check the signatures of the address bus.
- Connect signature analyzer to ST10.

START/STOP connections to ST10.1/2

GND (ground) to ST10.4

CLOCK to ST10.3, when BU20 is connected to ST20.1/2.

Signature-analyzer settings

START  STOP  CLOCK 



Signatures of address bus:

On B17.8	(A0)	UUUU	On B1.21	(A8)	HC89
B17.7	(A1)	5555	B1.22	(A9)	2H70
B17.6	(A2)	CCCC	B1.23	(A10)	HPP0
B17.5	(A3)	7F7F	B1.24	(A11)	1293
B17.4	(A4)	5H21	B1.25	(A12)	HAP7
B17.3	(A5)	0AFA	B1.26	(A13)	3C96
B17.2	(A6)	UPFH	B1.27	(A14)	3827
B17.1	(A7)	52F8	B1.28	(A15)	755U

The corresponding signatures must also be checked on B2, B24, B18, B19, B20, B22, B21 and - if IEC-bus option is installed - on B1 (8291).

- Check of databus signatures
- Switch BU20 to ST20.2/3

Setting the signature analyzer:

START  STOP  CLOCK 

- Take the signatures from ST36.1-8 and check with use of Table 5-3 (appended).

With the signature analysis of the data bus, the EPROMs are also checked.

The corresponding signatures must also be checked on B16, B17, B18, B19, B20, B22, B25 and - if the IEC-bus option is installed - on B1 (8291A).

- After completion of the signature analysis, reposition shorting link BU19 on ST19.1/2.

c) Check of Display/key control B16 (8279)

- Check of control signals for display/key decoding

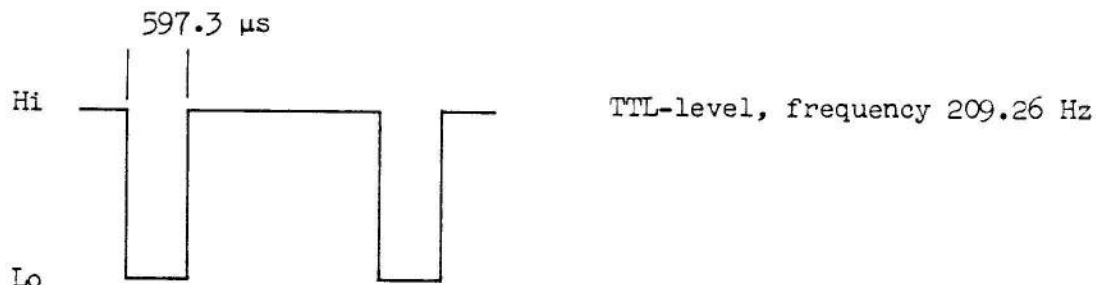

On B16.38 RLO

provided one of the keys S1, S4, S7, S10, S13 or S16 is pressed.

.39 RL1

provided one of the keys S2, S5, S8, S11, S14 or S17 is pressed.

.40 RL2

provided one of the keys S3, S6, S9, S12, S15 or S18 is pressed.

Rectangular signal,

TTL-level:

On B16.32 RSO  $f = 837.05 \text{ Hz} = \text{clock-frequency: } 3584$

.33 RS1  $f = 418.53 \text{ Hz} = \text{clock-frequency: } 7168$

.34 RS2  $f = 209.26 \text{ Hz} = \text{clock-frequency: } 14336$

.35 RS3  $f = 104.63 \text{ Hz} = \text{clock-frequency: } 28672$

On B16.24 - .27, .28 - .31 A0 - A3, B0 - B3

Pulse with level 0/+0.8 V, timing dependent on activation of digit segments, illuminated display fields and key illumination.

d) Check of INPUT/OUTPUT RAM 8155

- Check output port PA for activation of optocoupler interface with logic probe or oscilloscope.

On B2.21 - 28 (8155), PA0 - PA7 pulse with TTL-level, timing dependent on activation of analog section (control signals for analog switch, D/A converter).

- Check of timer output

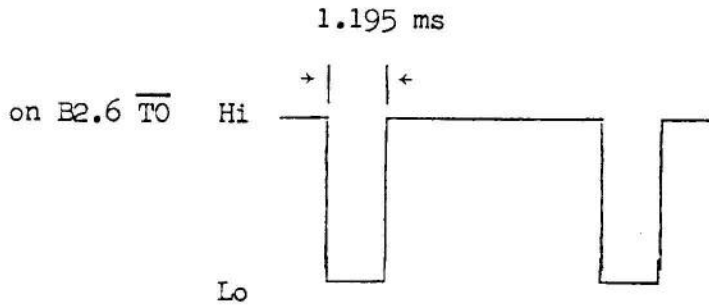

TTL-level  
 Frequency 119.579 Hz  
 = clock-freq: 25088

#### 5.2.4 Troubleshooting and Check of IEC-bus Interface

See Circuit Diagrams 342.1214 S and 342.2910 S

- Check the functioning of Address/TALK-ONLY switch.  
 Check voltages on B2 (8155) of computer board.

	Function	IN (I)	OUT (O)
B2.5 PC5	NORMAL TALK ONLY	0 V (NORMAL)	+5 V (TALK ONLY)
B2.2 PC4	address A5	0 V	+5 V
B2.1 PC3	address A4	0 V	+5 V
B2.39 PC2	address A3	0 V	+5 V
B2.38 PC1	address A2	0 V	+5 V
B2.37 PC0	address A1	0 V	+5 V

- Check of Address/TALK-ONLY setting by calling service function 1 (section 2.3.3.7.2, Table 2-1, section 3.2.7).
- Check of signatures of address/databus on B1 (8291A) during signature analysis per section 5.2.3.2 b.
- Check of clock pulse and reset pulse on B1 (8291A) per section 5.2.3.2 a.
- Check of IEC-bus function with Listener/Talker addressing with IEC-bus controller according to setting instructions per section 2.3.4.

#### 5.2.5 Troubleshooting and Check of Analog Output

See Circuit Diagrams 342.1214 S and 342.2810 S.

- Check of power supply on the analog-output board:

Reference point ST10.1 (BU2) (same potential as for computer)	0 V
BU/ST19	+15 V +0.6 V
BU/ST20	-15 V $\pm$ 0.6 V
B33.5/14      without	approx. 11 V
B31.1          loading	approx. 26 V
B32.3          on BU1/2	approx. -26 V

Frequency of control generator B33 ...  $f = 18$  kHz.

- Check of D/A converter B15 and its activation.
- Defined setting of D/A converter B15 by calling service functions 7 and 8 (BU33 on computer board removed, section 2.3.3.7.2, Table 2-1).
- Service function 7 (analog output offset adjustment) sets the 12-bit inputs of B15 to High (TTL-level). Output voltage on BU1...-2.048 V  $\pm$  2 mV
- Service function 8 (analog output amplifier adjustment) sets the 12-bit inputs of B15 to Low (TTL-level). Output voltage on BU1...+2.047 V  $\pm$  2 mV

#### 5.2.6 Troubleshooting and Check of Display Board

See Circuit Diagrams 342.1214 S and 342.2410 S

For troubleshooting the display board, it is best to remove it from the URE, as follows:

- Remove the four Phillips-head screws retaining the front panel and remove the display window and keyboard covering plate.
- Remove four more Phillips-head screws and take off the display board from the front panel.
- Replace the front panel for troubleshooting.
- The display board can be tested in the operating state outside the URE via two flat cables and plug-in connections.

All display elements and keys are activated and interrogated by the computer board in multiplex operation via the display/keyboard 8279.

- Check of control signals from the computer board (8279) according to section 5.2.3.2c on B10, B11, T10 - T17 and their output signals.
- Check of driver transistors and of signals on the display elements and keys.

- Check of the proper functioning of the display elements with use of the display tests by calling the service function 0 (section 2.3.3.7.2, Table 2-1).

### 5.2.7 Troubleshooting and Check of Analog Board

See Circuit Diagrams 342.1214 S and 342.2210 S Sheets 1 and 2

The analog board is accessible after removal of the bottom cover (Fig. 5-3).

The most important test points, those of the 16-bit D/A converter and the units for activating the analog functions are directly accessible. For additional measurements, the shielding cover must be removed by gently prying it off. After removal of two Phillips-head screws on the front side of the analog board and pulling off the input line K1 (on ST7), the analog board can be swivelled outward (Fig. 5-2). After removal of another shielding cover, the soldering side is accessible.

After completion of the work on the board, care must be taken in reassembling it to properly seat the shielding cover, plug-in connections and screws.

Reference potential for the check of signal, control and supply voltages is the outside conductor of the insulated BNC socket and the shielding box of the analog board (potential isolation from the computer section).

#### 5.2.7.1 Check of Interface Functions

##### Analog/Computer Sections

By calling service function 6 (Rectifier adjustment), a defined static state of the analog functions and the interface function can be achieved. This makes possible a check by means of simple voltage measurements.

- Call service function 6.
- Check the control voltages on the analog board:

Reference potential: Shielding enclosure 0 V			
On		On	
B4.9 (RS 1 IN)		B4.11/12, 13/ .2/3/5/6/7	
B4.10 (RS 2 IN)		B3.2/3/5/6/7	
B4.14 (B1 III IN)		B5.9/10/11/12	
B4.1 (T31 OUT)		.2/3/5/6/7/13/14	
B4.15 (T32 OUT)		B12.1/2/3/5/6/7/15	
B5.1 (T45, T47 OUT)			
B5.15 (T35 IN)			
B12.13 (T50 IN)			
B12.14 (B36 I IN)			
B15.13 (T37, T38, T40 IN) .12 (B14I IN)	+5 V	B15.9/1/2/3/5/6/10/ .7/11/14	0 V
B15.15 (T51 IN)			
B3.4			
B4.4			
B5.4			
B12.4			
B15.4			
B30.4		B30.2/3/5/6/7	
B31.4		B31.2/3/5/6/7	

#### 5.2.7.2 Check of Input Circuit and Input Amplifier

- Check with test input shorted of operating points of input amplifier (T5, T6 - T14, T28) against values given in circuit diagram.
- Check of amplification switching and input switching: Apply a sinusoidal voltage of 200 kHz to the URE test input. Measure the output voltage on ST5 with an RF millivoltmeter as specified in Table 5-4.

URE setting:

Operating mode: AC

Measurement range: Manually set by calling service function 2

(section 2.3.3.7.2) and entering range number.

Table 5-4

Measurement range		Input voltage	Voltage measured at ST5	
Number	Volt. range		Rated value	Typ. deviation
05	100 mV	100 mV	179.5 mV	+0.5%
02	3 mV	3.162 mV	57.09 mV	+1%
07	1 V	1 V	17.95 mV	+1%
11	100 V	10 V	17.95 mV	+1%

5.2.7.3 Check of Range Divider and Buffer Amplifier

- Check with test input shorted of operating points of buffer-amplifiers B9, T18, T19, T21, T22, T30 against values given in circuit diagram.
- Check of the amplification and divider factors:  
Apply a 200-kHz sinusoidal voltage to the URE test input. Measure the output voltage on BU/ST19 with an RF millivoltmeter as specified in Table 5-5. URE settings as in section 5.2.7.2.

Table 5-5

Measurement range		Input voltage	Voltage measured on BU/ST19	
Number	Volt. range		Rated value	Typ. deviation
03	10 mV	10 mV	30.15 mV	+1%
04	30 mV	31.62 mV	30.09 mV	+1%
05	100 mV	100 mV	30.04 mV	+1%
06	300 mV	316.2 mV	30.08 mV	+1%

For the periodic calibration of the rectifier at 9-sec to 16.5-sec intervals, the amplifier branch is temporarily opened up at the main divider. This results in an interruption of the static measurements of the operating points and amplification values.

5.2.7.4 Check of Push-pull Amplifier

URE settings:

Call service function 6 (rectifier adjustment)

- Check of operating points of the push-pull amplifier with no input signal as specified on the circuit diagram.

- Check amplification:

Apply a 200-kHz sinusoidal to the URE test input.

Measure the output voltage on ST4.1 and ST4.2 with an RF millivoltmeter.

Measurement range	Input voltage	Voltage measured on ST4.1 and ST4.2	
		Rated value	Typ. deviation
100 mV <sup>+) )</sup>	100 mV	150 mV	+2%

+ ) Automatically set by service function 6

- Check of offset voltage at push-pull-amplifier output according to section 5.3.1.2.1:

Offset voltage between ST4.1 and ST4.2: 0 V +10 mV typically.

#### 5.2.7.5 Check of RMS-value Rectifier

URE settings: as in section 5.2.7.4.

- Check of operating points of rectifier amplifier with no input signal:

Reference potential at ST2.1	0 V
On B20.6 and B21.6	0 V <u>+10</u> mV typ.
B22.3	+0.76 V
B22.6 and ST2.4	+2.8 V
and B23.1/2/3	
ST2.2 and ST8.1	-8.43 V typ. -7.03 V ... -9.97 V max.

- Check of operating points of push-pull amplifier and FET rectifier bridge:  
Apply 100-mV sinusoidal at 100 Hz to URE test input.  
With oscilloscope check points ST4.4 and ST4.5 to see that the balance condition is attained.



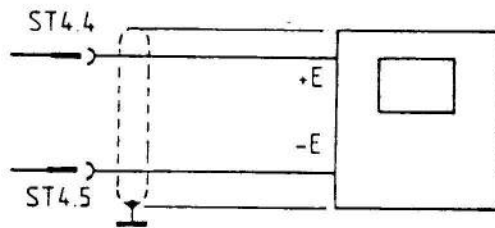

Oscilloscope  
(Difference setting)

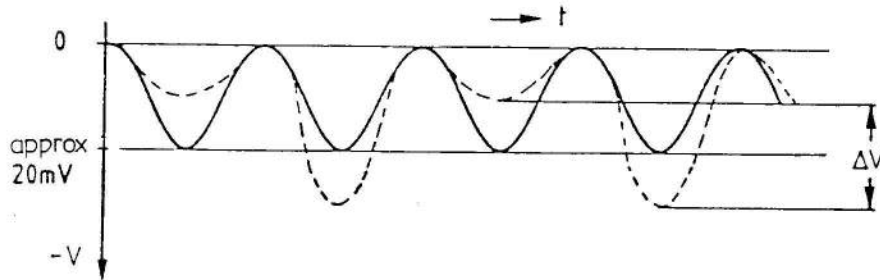

Correct setting:  
- Amplitudes equal  
- Incorrect setting:  
- Amplitudes different  
Adjustment required  
(section 5.3.1.2.2)

- Check of rectifier output per section 5.3.1.2.3.

#### 5.2.7.6 Check of DC-Amplifier Branch

A check is required only after the error messages `E r r 1` (DC offset error) or `E r r 8` (calibration value wrong) or their combination according to section 5.2.1.2.

URE settings:

Operating mode: AC+DC

Measurement range: Manually set by use of service function 2 and entry of range number 1 - 12.

Filters: FAST

Check of DC offset voltage:

- Short circuit URE input.
- Connect digital voltmeter across DC-amplifier output B10.6 and ST2.1 (reference).
- The DC offset voltage must not exceed  $\pm 1.3$  V in measurement ranges 1 through 12.

Check of DC amplification:

Test setup according to Fig. 3-5.



The offset of the input amplifier is corrected at the start of the autocalibration. The process can be observed at the output ST11 of the offset correction circuit. An end value is obtained by approximation in binary steps with 8-bit resolution that corresponds to an offset value of about 0 V  $\pm$ 150  $\mu$ V for the input amplifier.

Output voltage on ST11 within the limits  $\pm$ 13 V,

Output voltage on ST5 ..... 0 V  $\pm$ 3 mV typ.

5.2.7.7 Check of Reference Voltages

URE settings:

Call of service function 9.

- Check of DC reference voltages with digital voltmeter, with settings and conditions specified in section 5.3.1.1.

Reference potential at ST6.1 = 0 V	
On B25.24 and B2.3	6.3 V $\pm$ 5%
B1.1	10 V $\pm$ 0.1% typ.
ST6.2	10 V $\pm$ 0.01%
	1 V $\pm$ 0.01%
	0.1 V $\pm$ 0.01%

- Check of AC reference voltages at service function 9, code number 2:

With oscilloscope measure

on B16.2/3/6 a rectangular signal of 5 kHz and 1 V amplitude,

on B13.10 and B13.11 a rectangular signal of 5 kHz and 15 V amplitude, complementary to one another.

With RMS measuring instrument measure at B17.9

$V_{rms} = 30 \text{ mV } \pm 1\%$ .

### 5.3 Adjustment of the URE

This section contains all test and adjustment procedures which may be necessary in the adjustment of the individual functional groups and of the entire instrument. An adjustment may only be made after the instrument has attained its steady operating temperature obtained after at least 30 minutes of operation. The ambient temperature should be +20 to +25°C. Only the two covers may be removed for adjustments. The test setups required for the measurements are those given in section 3.2 for check of rated values.

After any adjustment, the instrument may only be regarded as fully operational when all characteristics are checked against rated values according to section 3.2.

#### 5.3.1 Adjustment of the Analog Board

For the adjustments, the lower cover of the instrument is removed and the instrument placed on its side. An insulated adjustment tool with an outer diameter of 7 mm maximum and a slot-width of about 3 mm should be used. The location of the adjusting elements is shown in Fig. 5-3.

| The adjustments must be made in the order given below! |

##### 5.3.1.1 Adjustment of Reference Voltages

- Call service function 9 and enter code digit 0, 1 or 2.
- With digital voltmeter connected across points ST6.2 and ST6.1 (reference) adjust the reference voltage to its rated value as given in Table 5-7.

10-V reference:

Call service function 9 and enter code digit 2:

Rough setting of rated value of 10-V reference, required in case of new adjustment or after changing B25:

- Gently pry off the shielding cover from analog board.
- Connect opened wire bridges D3, D4, D5.
- With R39 adjust to maximum value of output voltage.
- Open wire bridges according to Table 5-7.

Table 5-7

Wire bridges to be opened	Output voltage at ST6.2 Volts
-	< 10.1
D3	10.1 to < 10.26
D4	10.26 to < 10.4
D3, D4	10.40 to < 10.54
D5	10.54 to < 10.69
D3, D5	10.69 to < 10.83
D4, D5	10.83 to < 10.97
D3, D4, D5	≥ 10.97

Fine setting: With the shielding cover in place on analog board and no input signal on URE.

Table 5-8

Service function 9		Reference voltage		Adjusted with
Code digit	Indication	Rated value	Permitted deviation for adjustment	
2	9 10 V	10 V	+0.2 mV	R39
1	9 1 V	1 V	+50 μV	R33 <sup>+) </sup>
0	9 100 mV	0.1 V	+5 μV	R36 <sup>+) </sup>

+ ) There is a slight interaction between the R33 and R36 settings. Therefore, repeat 1-V and 0.1-V adjustments.

Note: After adjustment of the reference voltages, an autocalibration must be performed - see section 3.3.1.

### 5.3.1.2 Rectifier Adjustment

Call service function 6 of URE.

#### 5.3.1.2.1 Offset Adjustment of Push-pull Amplifier

- Remove input signal.
- Connect digital voltmeter across ST4.1 and ST4.2 (Push-pull amplifier output).

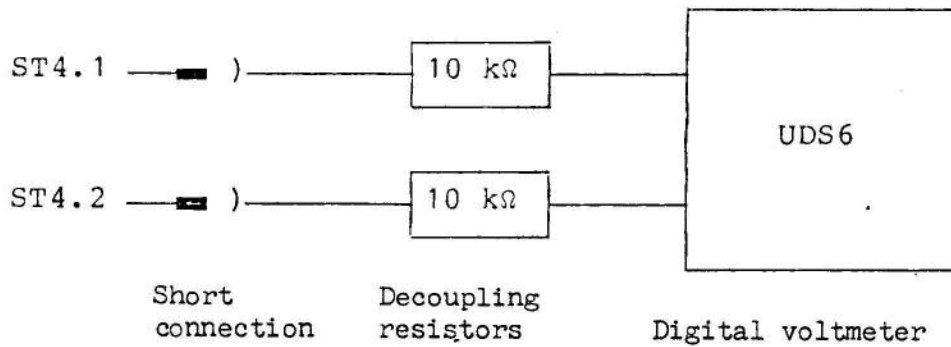

- With R174, adjust voltage to 0 V  $\pm$  1 mV.

#### 5.3.1.2.2 Balance Adjustment

- Apply a 100-mV sinusoidal wave at 100 Hz to the URE test input.
- Connect AC voltmeter with difference input and peak indication to output of rectifier bridge between ST4.4 and ST4.5. Use shielded cables.
- With R139 adjust to minimum peak-value indication on AC voltmeter.

#### 5.3.1.2.3 Adjustment of Rectifier Amplifier

Required only after a new adjustment or replacement of rectifier FET T27.

- Gently pry off the shielding cover of the analog board.
- Connect opened wire bridges D1, D2.
- Apply a 100-mV sinusoidal wave at 100 Hz to the URE test input.
- With digital voltmeter measure DC voltage across ST2.2 and ST2.1 (reference).
- Determine the difference between output voltages for inputs of 100 mV and 0 V.

- Set the amplification by opening the wire bridges according to Table 5-9.

Table 5-9

$\Delta V$ volts	Amplification of rectified voltage	Wire bridges to be opened
< 8.9	1046	-
8.9 to < 10.2	914	D1
10.2 to < 12.2	762	D2
$\geq$ 12.2	630.6	D1, D2

After prescribed amplification settings we must have

$$6.20 \text{ V} \leq \Delta V_{\text{out}} \leq 10.20 \text{ V.}$$

If the values above are not attained, message E r r 4 is displayed.

#### 5.3.1.3 Adjustment of 1-dB Input Divider

URE settings:

Operating Mode: AC  
 Display mode: V  
 Measurement range: Set by calling service function 2 and entering range number 5 (200 mV).

Filters: LOW PASS out, SLOW

Test setup as in Fig. 3-1.

- Apply 100-mV sinusoidal wave to URE test input.
- Set signal frequency to 100 Hz and read displayed value (about 100 mV).
- Set signal frequency to 10 kHz and with C15 adjust displayed value to that obtained with 100 Hz.

#### 5.3.1.4 Absolute-value Adjustment of AC Indication

- Initiate URE autocalibration by calling service function 4 (sections 2.3.3.7.2 and 3.3.1).
- Call service function 5 (absolute value adjustment).

Test setup as in Fig. 3-1:

- Apply 100-mV sinusoidal wave at 1 kHz to URE test signal input.
- With R171, set displayed value to 100.00 mV  $\pm$  1 digit.

### 5.3.1.5 Adjustment of Frequency Characteristic

URE settings:

Operating mode: AC

Display mode: V

Measurement range: Set by calling service function 2 and entering range number according to Table 5-10.

Filters: LOW PASS out, SLOW

- Signal setting with test setups of Figs. 3-1, 3-2, 3-3 and setting procedures of section 3.2.2.



Table 5-10

Meas. range		Input		Displayed value on URE	Adjustment procedure
No.	Voltage	Voltage	Freq.		
07	1 V	1 V	100 Hz	1.0000 V +0.1% typ.	-
		1 V	10 kHz		
11	100 V	100 V	100 Hz	100.00 V +0.1% typ.	-
		100 V	10 kHz		
The C8 and C13 settings interact slightly, so that the above adjustments should be repeated. One repetition normally suffices.					
05	100 mV	100 mV	10 kHz	100.00 mV +0.1% typ.	-
		100 mV	10 MHz		
02	3 mV	3.162 mV	10 kHz	3.162 mV +0.1% typ.	-
		3.162 mV	10 MHz		
The C21 and C24 settings interact slightly, so that the adjustments should be repeated.					
07	1 V	1 V	10 kHz	1.0000 V +0.1% typ.	-
		1 V	10 MHz		

In the adjustments of C8, C13, C21 and C24, the display value may be slightly influenced by the adjusting tool. The displayed value should be noted with the tool applied and removed and the difference allowed for in the setting.

### 5.3.2 Adjustment of Analog Output

(When Analog-output Option URE-B2 is fitted)

- Call service function 7 or 8 as required.
- Connect digital voltmeter to unloaded analog output.
- Remove top cover (after loosening 4 Phillips-head screws).  
Fig. 5-1 identifies the adjustable elements.
- Adjust the DC voltages to values given in Table 5-11 in the order listed.

Table 5-11

URE setting	Analog-output voltage	
	Rated value	Adjustment
Service function 7 (offset adjustment)	-2.048 V $\pm$ 0.1 mV	With R45 to required value
Service function 8 (amplification adjustment)	+2.047 V $\pm$ 0.1 mV	With R46 to required value

### 5.4 Spare Parts

The appended Circuit Components Lists contain the Order Numbers for all electrical parts.

To assure the highest possible reliability of the instrument, the electrical components manufactured in line with special R&S specifications are further subjected to rigorous quality controls before being released for use.

It is therefore recommended that any component that may have become defective be replaced only by R&S-tested spares.